

HCFA Q series HCQX Remote Extension Modules Hardware Instruction

1 Introduction

Thank you for purchasing and using the Q series remote extension modules independently developed and produced by HCFA Corporation.

Table with 4 columns: Name, Module, Version, Power, Description. Lists various HCQX modules like HCQX-EC01-D, HCQX-ID16-D, etc.

When the user selects modules according to the power, part of the power is reserved to avoid the loss during the signal transmission.

Applicable readers For the users of HCFA Q series extension modules, refer to the instruction to perform the wiring, installation, diagnosis and maintenance and requires the use of the certain knowledge of electrical and automation.

1.1 Safety Precautions

When using this product, please follow the following safety precautions and instructions strictly. Users can check more specific safety guidelines in sections such as mounting, wiring, communication, etc.

DANGER WARNING CAUTION Note. Safety symbols and their meanings.

Key points or explanations to help with better operation and understanding of product.

1.1.2 Safety symbols

STARTUP/MAINTENANCE PRECAUTIONS. Do not touch any terminal while the PLC's power is on.

CAUTION. Do not disassemble or modify the PLC. Do not touch any terminal while the PLC's power is on.

CAUTION. Do not touch any terminal while the PLC's power is on. Do not touch any terminal while the PLC's power is on.

CAUTION. Do not touch any terminal while the PLC's power is on. Do not touch any terminal while the PLC's power is on.

CAUTION. Do not touch any terminal while the PLC's power is on. Do not touch any terminal while the PLC's power is on.

CAUTION. Do not touch any terminal while the PLC's power is on. Do not touch any terminal while the PLC's power is on.

CAUTION. Do not touch any terminal while the PLC's power is on. Do not touch any terminal while the PLC's power is on.

2 Product Overview

2.1 Model name description

HC QX-EC01-D. Model name description for system modules. Includes diagram and table of terminal functions.

2.3 Product Dimensions

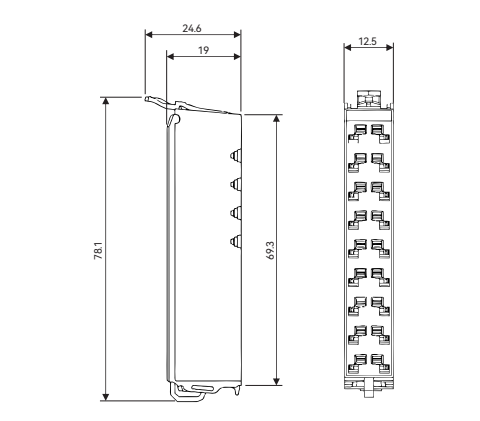
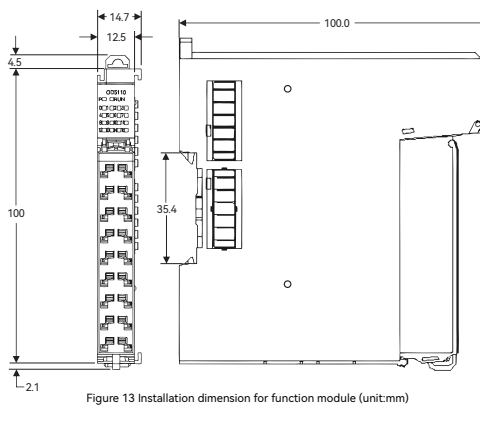
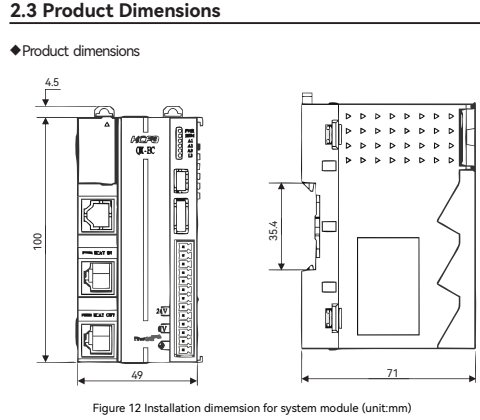

MODEL-HCQX-ID16-D. Model name and nameplate description for HCQX-ID16-D. Includes barcode and technical specifications.

2.1.2 Model name description for function modules

HC QX-ID XX-D. Model name description for function modules. Includes diagram and table of terminal functions.

MODEL-HCQX-ID16-D. Model name and nameplate description for HCQX-ID16-D. Includes barcode and technical specifications.

2.2 Part name description

2.2.1 Main view for New coupler module HCQX-EC01-D

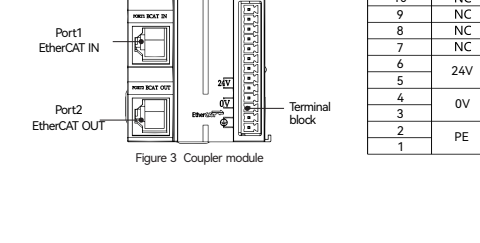

2.2.2 Main view for digital input module HCQX-ID16-D

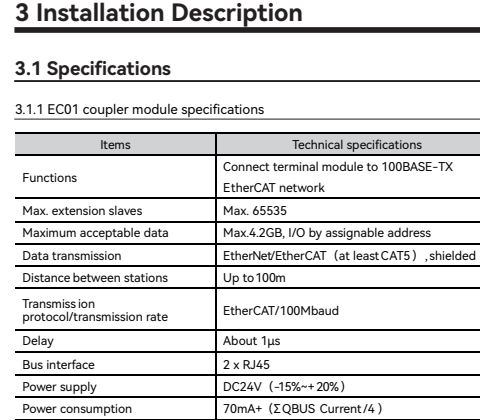

2.2.3 Main view for digital output module HCQX-OD16-D

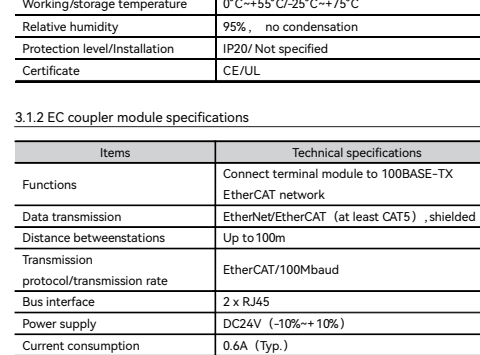

2.2.4 Main view for digital I/O module HCQX-IO16-D

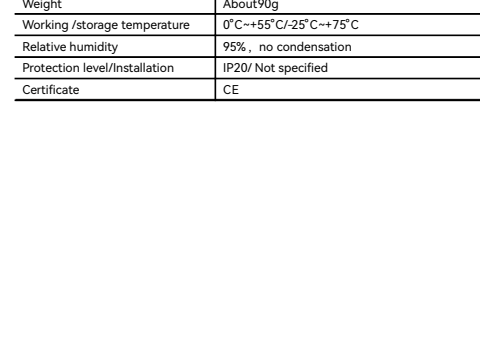

2.2.5 Main view for analog input module HCQX-AD04-D



Symbol/Color Description. Legend for indicator lights and colors.

2.2.6 Main view of analog output module HCQX-DA04-D

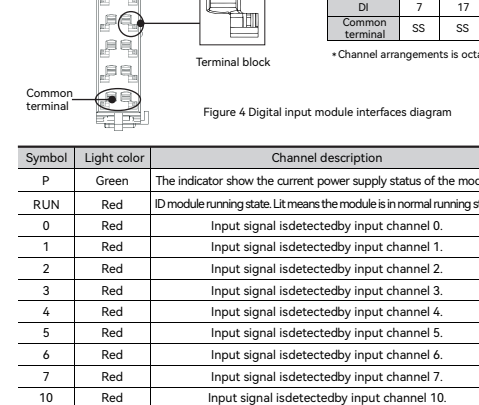

2.2.7 Main view for temperature measurement module HCQX-TSD04-D

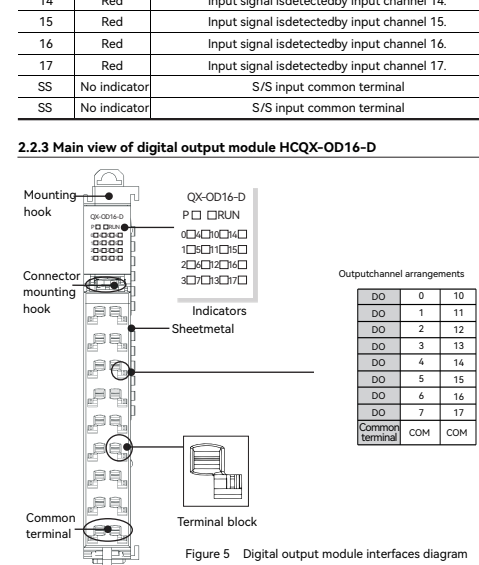

2.2.8 Right view for extension modules

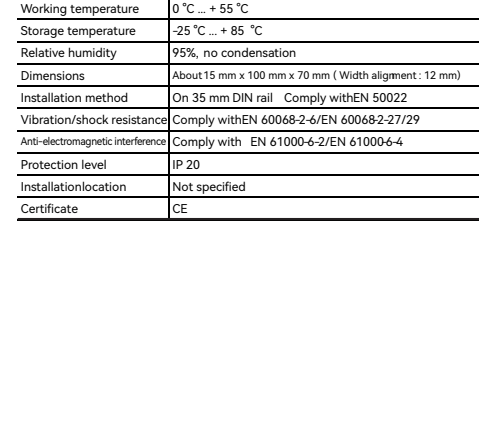
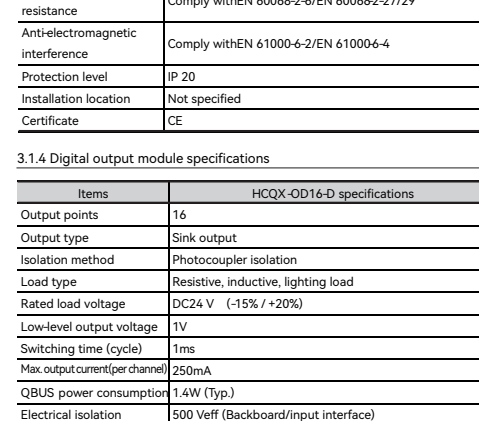
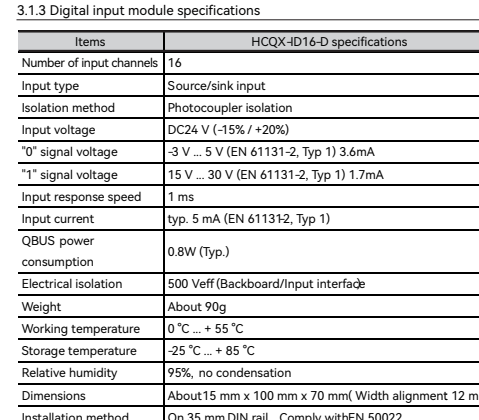

2.2.9 Main view of analog input module HCQX-AD04-D



Symbol Light color Channel description. Legend for indicator lights and colors.

2.2.10 Main view of digital I/O module HCQX-IO16-D

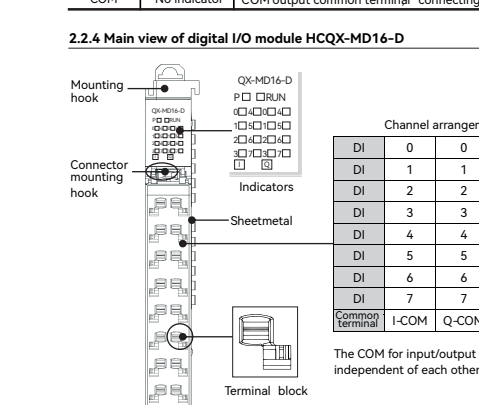

2.2.11 Main view of analog input module HCQX-AD04-D

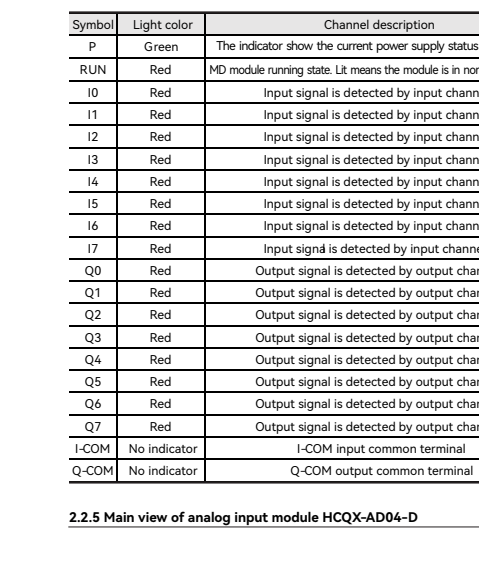

2.2.12 Main view of analog output module HCQX-DA04-D

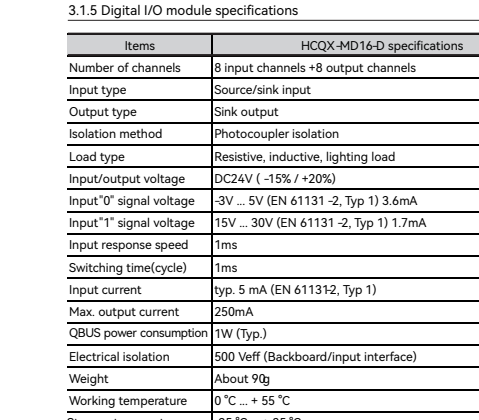

2.2.13 Main view for temperature measurement module HCQX-TSD04-D

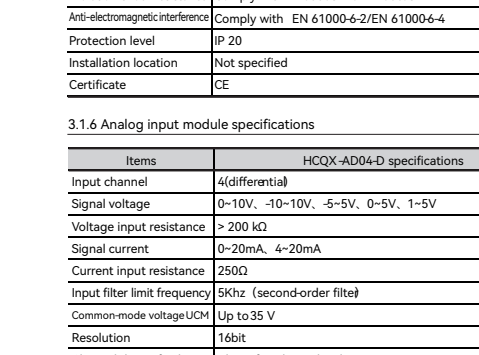

2.2.14 Main view of digital input module HCQX-ID16-D

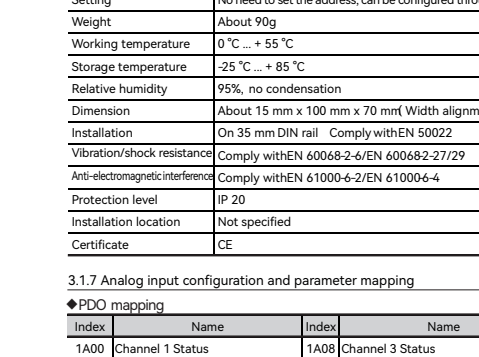

2.2.15 Main view of analog input module HCQX-AD04-D

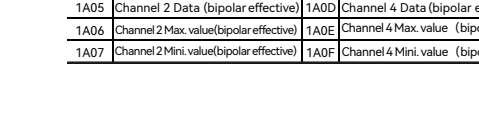

Symbol Light color Channel description. Legend for indicator lights and colors.

2.2.16 Main view of analog output module HCQX-DA04-D

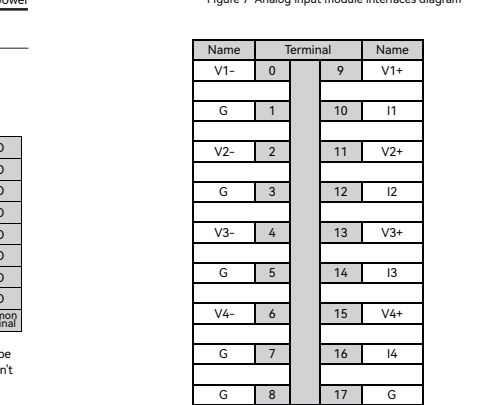

2.2.17 Main view for temperature measurement module HCQX-TSD04-D

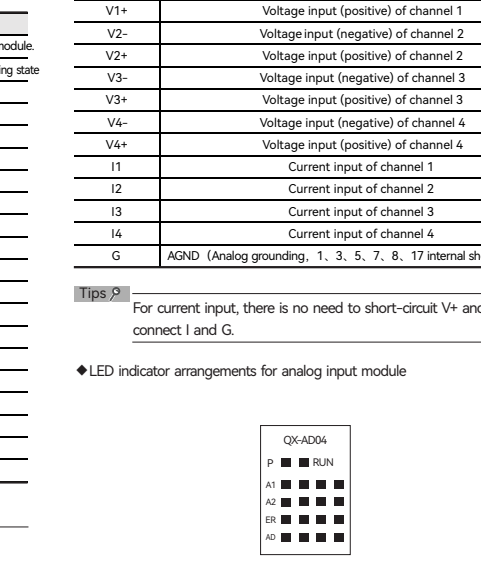

2.2.18 Main view of digital input module HCQX-ID16-D

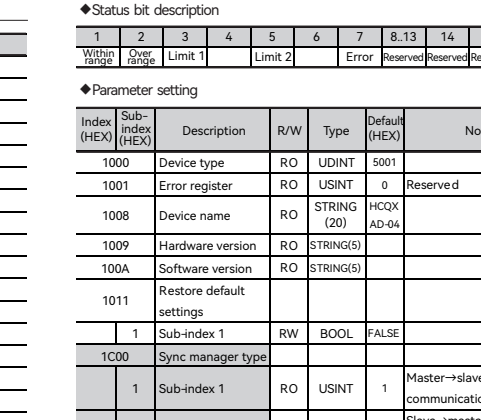

2.2.19 Main view of analog input module HCQX-AD04-D

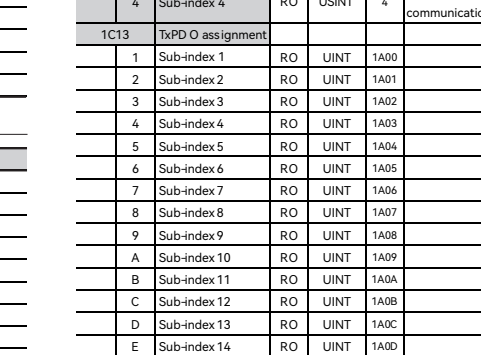

2.2.20 Main view of analog output module HCQX-DA04-D

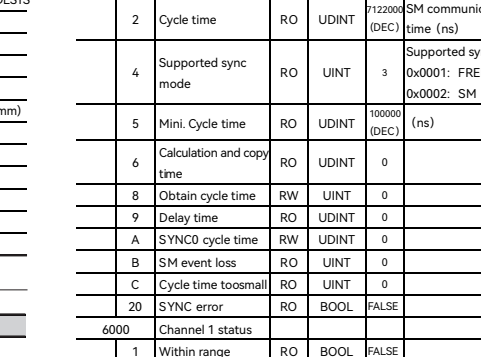

2.2.21 Main view for temperature measurement module HCQX-TSD04-D

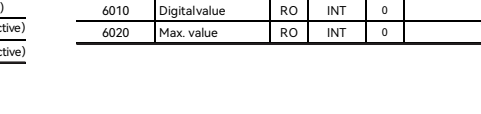

Symbol Light color Channel description. Legend for indicator lights and colors.

2.2.22 Main view of analog output module HCQX-DA04-D

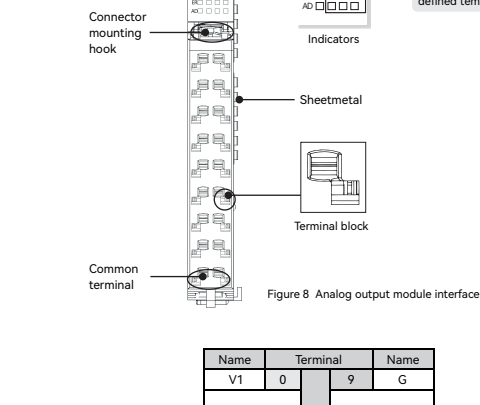

2.2.23 Main view for temperature measurement module HCQX-TSD04-D

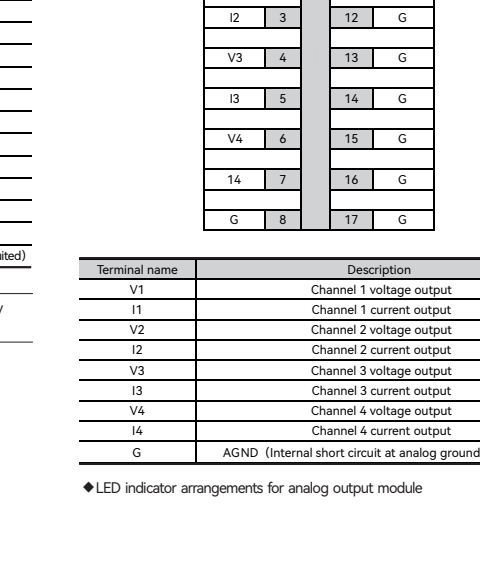

2.2.24 Main view of digital input module HCQX-ID16-D

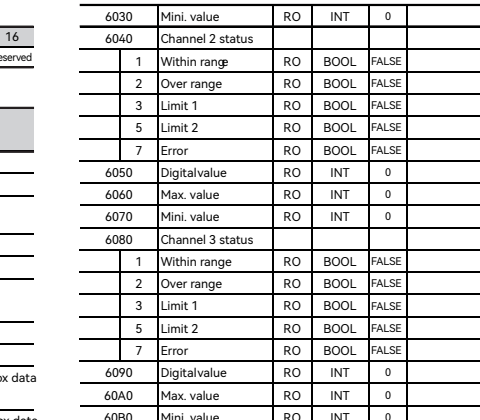

2.2.25 Main view of analog input module HCQX-AD04-D

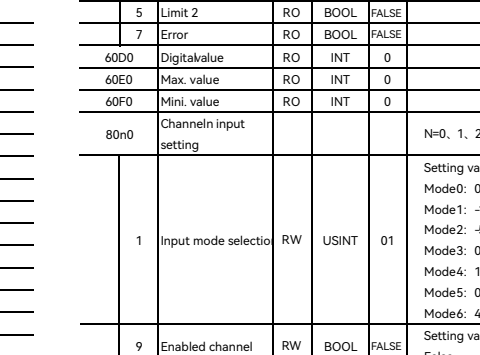

2.2.26 Main view of analog output module HCQX-DA04-D

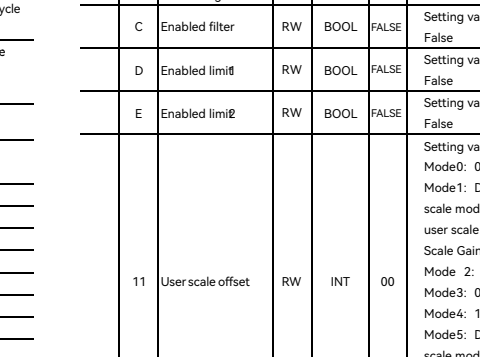

2.2.27 Main view for temperature measurement module HCQX-TSD04-D



Symbol Light color Channel description. Legend for indicator lights and colors.

2.2.28 Main view of analog output module HCQX-DA04-D

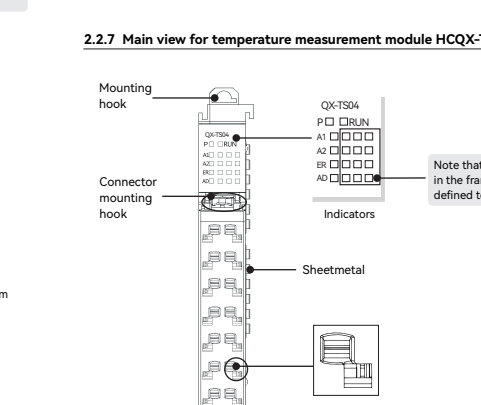

2.2.29 Main view for temperature measurement module HCQX-TSD04-D

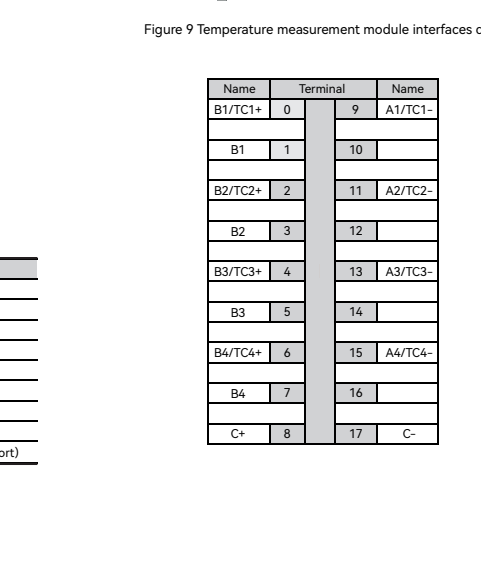

2.2.30 Main view of digital input module HCQX-ID16-D

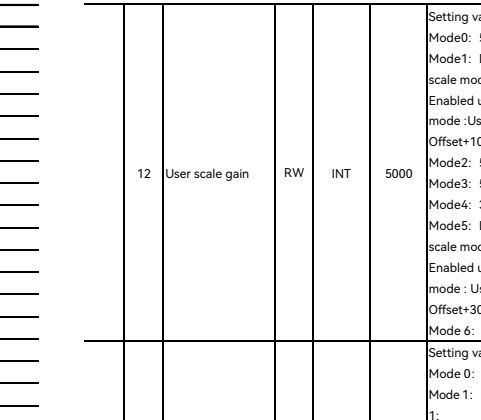

2.2.31 Main view of analog input module HCQX-AD04-D

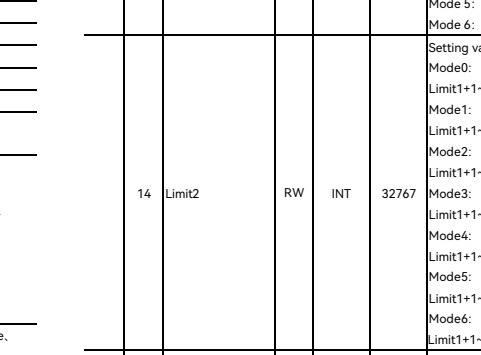

2.2.32 Main view of analog output module HCQX-DA04-D

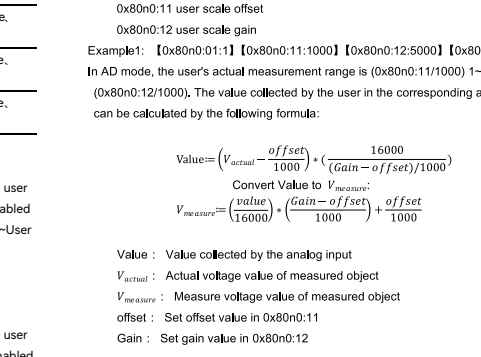

2.2.33 Main view for temperature measurement module HCQX-TSD04-D

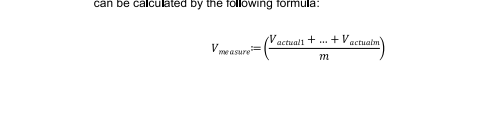
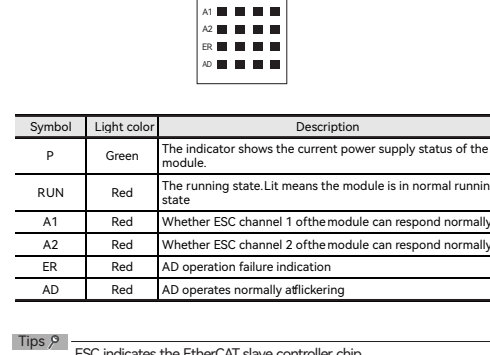
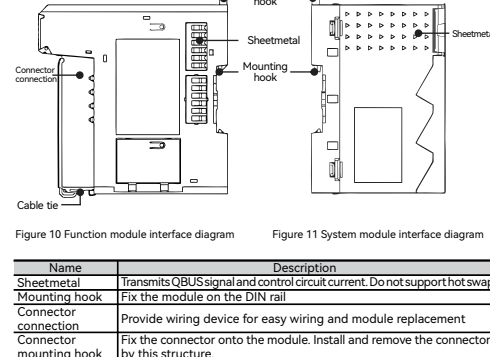

Table with 2 columns: Terminal name, Description. Lists terminal functions for various modules.

LED indicators arrangements for temperature measurement module



LED indicators arrangements for analog input module



LED indicators arrangements for analog output module

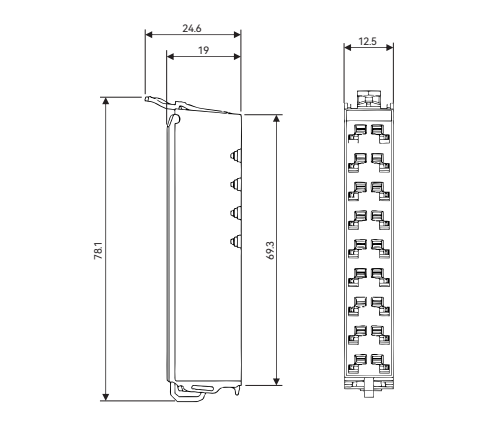
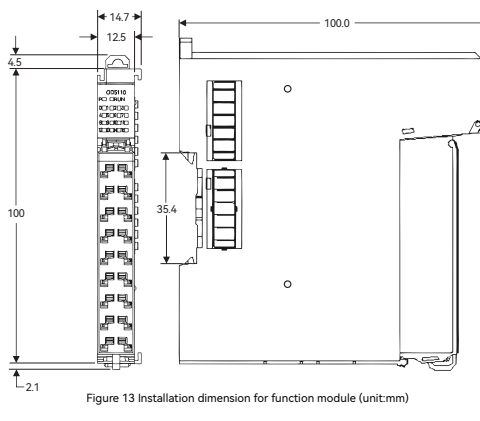
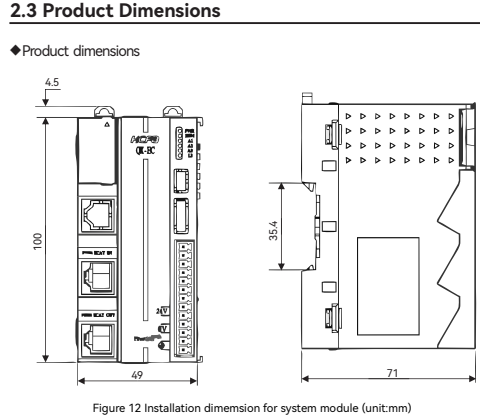

2.3 Installation Description

3.1.1 EC01 coupler module specifications. Technical specifications for the EC01 coupler module.

3.1.2 EC coupler module specifications. Technical specifications for the EC coupler module.

3.1.3 Digital input module specifications. Technical specifications for the digital input module.

3.1.4 Digital output module specifications. Technical specifications for the digital output module.

3.1.5 Analog input module specifications

3.1.5 Analog input module specifications. Technical specifications for the analog input module.

3.1.6 Analog output module specifications. Technical specifications for the analog output module.

3.1.7 Temperature measurement module specifications. Technical specifications for the temperature measurement module.

3.1.8 Digital I/O module specifications. Technical specifications for the digital I/O module.

3.1.9 Analog input module specifications

3.1.9 Analog input module specifications. Technical specifications for the analog input module.

3.1.10 Analog output module specifications. Technical specifications for the analog output module.

3.1.11 Temperature measurement module specifications. Technical specifications for the temperature measurement module.

3.1.12 Digital I/O module specifications. Technical specifications for the digital I/O module.

3.1.13 Analog input module specifications

3.1.13 Analog input module specifications. Technical specifications for the analog input module.

3.1.14 Analog output module specifications. Technical specifications for the analog output module.

3.1.15 Temperature measurement module specifications. Technical specifications for the temperature measurement module.

3.1.16 Digital I/O module specifications. Technical specifications for the digital I/O module.

3.1.17 Analog input module specifications

3.1.17 Analog input module specifications. Technical specifications for the analog input module.

3.1.18 Analog output module specifications. Technical specifications for the analog output module.

3.1.19 Temperature measurement module specifications. Technical specifications for the temperature measurement module.

3.1.20 Digital I/O module specifications. Technical specifications for the digital I/O module.

3.1.21 Analog input module specifications

3.1.21 Analog input module specifications. Technical specifications for the analog input module.

3.1.22 Analog output module specifications. Technical specifications for the analog output module.

3.1.23 Temperature measurement module specifications. Technical specifications for the temperature measurement module.

3.1.24 Digital I/O module specifications. Technical specifications for the digital I/O module.

3.1.25 Analog input module specifications

3.1.25 Analog input module specifications. Technical specifications for the analog input module.



The user display configuration is determined by index 0x80n0.01, where the user can modify the working mode of the channel to display values in different measurement ranges. The analog module has a 16-bit resolution and the maximum display range is -32768... to +32767... The measured and displayed values in different modes are as follows:

Table with 3 columns: Input/output signal, Value, and Hexadecimal. It lists conversion ranges for various input types like 10V/20mA, 0V/5V, etc.

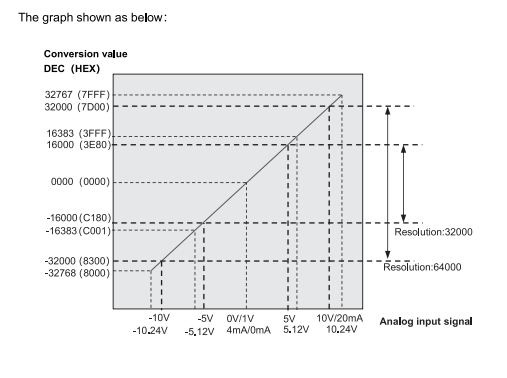

3.1.9 Analog output module specifications

Table with 2 columns: Items and Description. It lists specifications for output channels, signal voltage, current, accuracy, resolution, channel data refresh time, voltage load, current load, QBUS over consumption, electrical isolation, process image bit width, weight, working temperature, storage temperature, relative humidity, dimensions, installation, vibration/shock resistance, EMC resistance, protection level, and certificate.

Large table for parameter mapping. It includes sections for PDO mapping (Index, Name, Channel) and Parameter setting (Index, Sub-index, Description, R/W, Type, Default, Notes). It details settings for channels 1-4, including device type, error register, device name, hardware version, software version, restore default, sync manager type, sub-index, and output value.

The user display configuration is determined by index 0x80n0.01, where the user can modify the working mode of the channel to display values in different measurement ranges. The analog module has a 16-bit resolution and the maximum display range is -32768... to +32767... The measured and displayed values in different modes are as follows:

Table with 3 columns: Input/output signal, Value, and Hexadecimal. It lists conversion ranges for various input types like 10V/20mA, 0V/5V, etc.

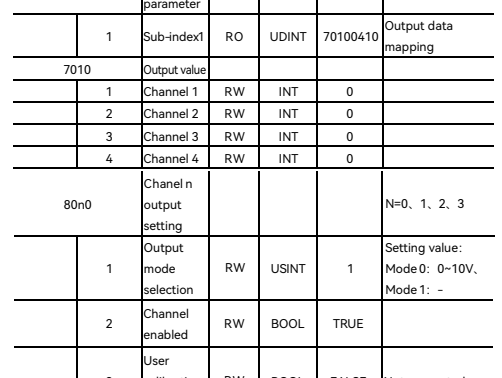

3.1.12 Temperature measurement module specifications

Table with 2 columns: Items and Description. It lists specifications for input channel, power input, signal voltage, setting, input filter limit frequency, resolution, warm-up time, absolute maximum rating, conversion time, and temperature range.

Table for parameter setting. It includes sections for PDO mapping (Index, Sub-index, Description, R/W, Type, Default, Notes) and Temperature range for thermocouple and thermal resistance. It details settings for channels 1-4, including channel 1/2/3/4 detection, sensor type, filter word selection, cold-end setting, set temperature unit, and disconnection detection switch.

Table for performance parameters. It lists Sampling speed, Disconnection detection OFF, Disconnection detection ON, Sampling accuracy, and Connector wiring. It includes details on error rates, accuracy, and installation instructions for the connector.

Section 3.2 Wiring Description. Includes 3.2.1 Cable selection and connector wiring (Table with Item and Specifications), 3.2.2 Connector installation (Diagram showing connector alignment), and 3.2.3 Connector wiring (Diagram showing cable insertion and terminal clamping).

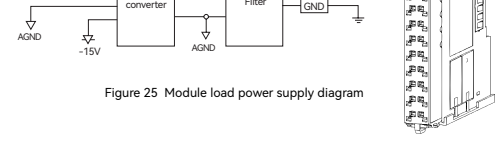
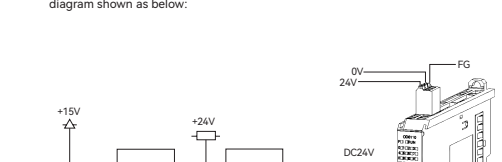
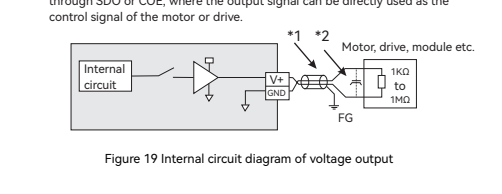
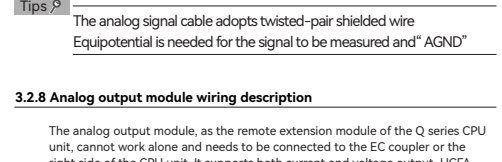
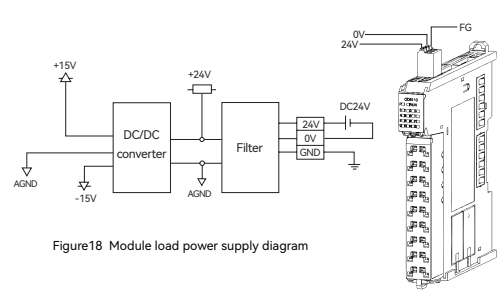
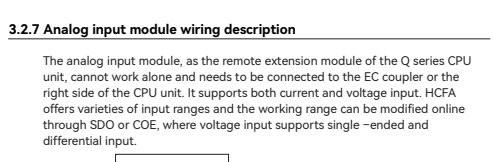
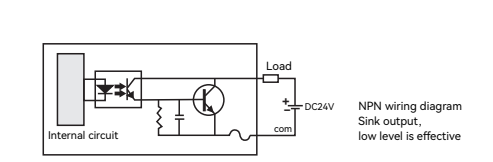
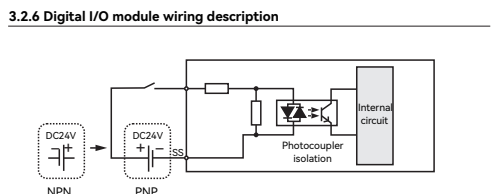
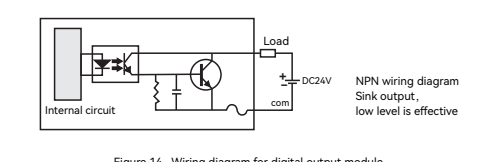
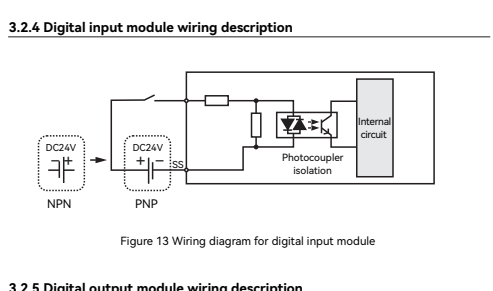
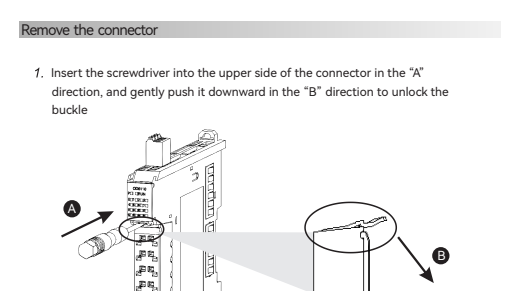

- 1) Distinguish the input/output cables and make the wiring separately.
2) If the power cable is close to I/O signal cable, error may occur because of high-voltage/coupling. The distance between I/O signal cable and power cable should be more than 100mm.
3) 24VDC I/O cable should be laid separately from AC power cable.
4) When using piping for wiring, make sure that the piping is well-grounded.

4.1 Programming example for digital module

This example uses the CPU unit HQ1-1300-D + coupler module HCQX-EC + digital module HCQX-ID16-D as an example to illustrate: (Q1) connection has been described briefly. For more details, refer to Q1 Software Manual.)

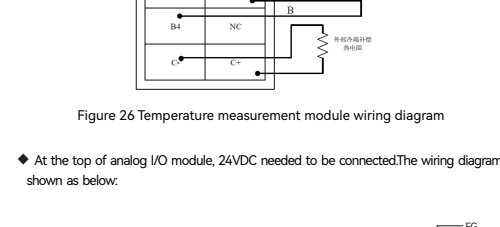

4.2 Programming example for analog module

This example uses the CPU unit HQ1-1300-D + coupler module HCQX-EC + analog module HCQX-AD04-D as an example to illustrate: (Q1) connection has been described briefly. For more details, refer to Q1 Software Manual.)

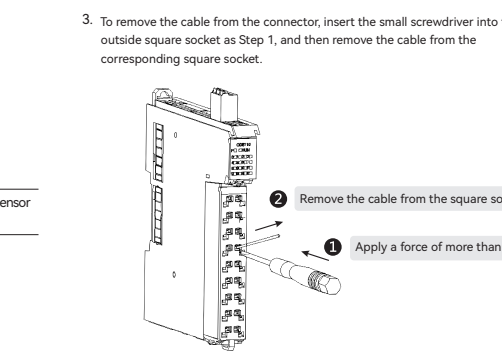
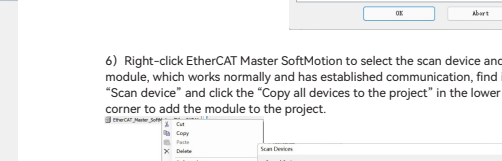
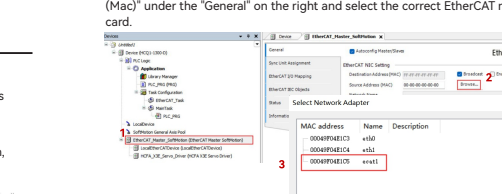
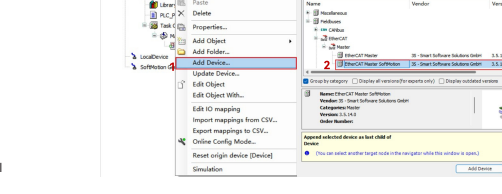
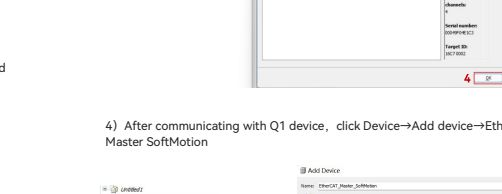
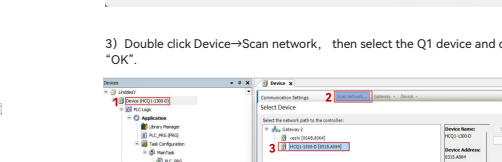
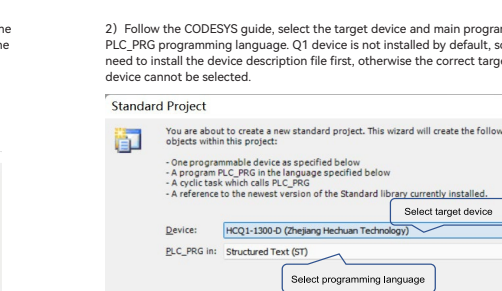
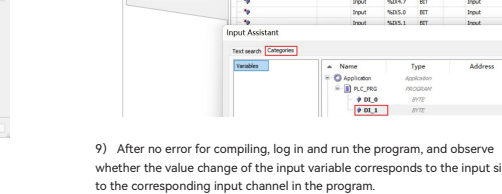
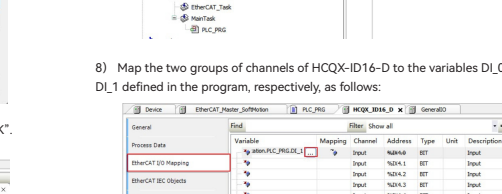
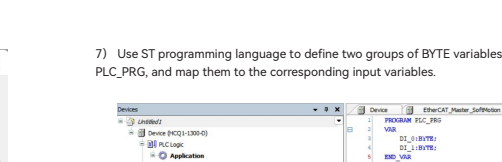
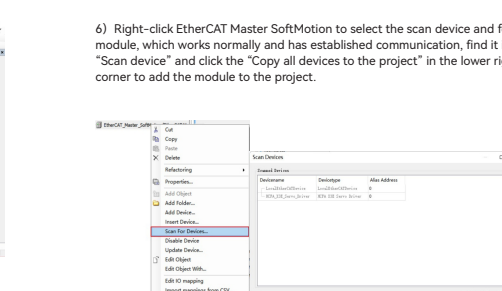
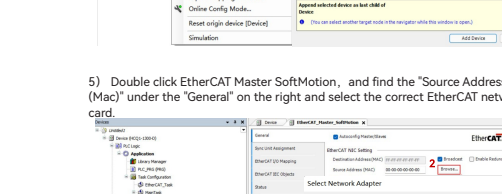
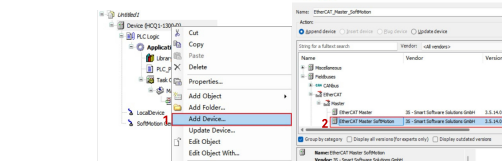
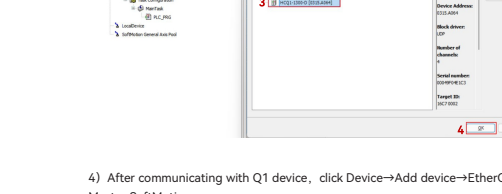
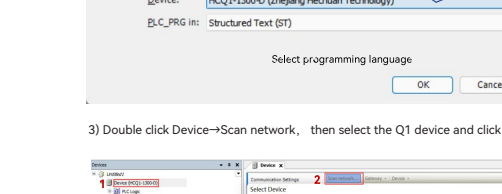
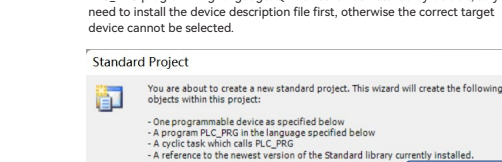
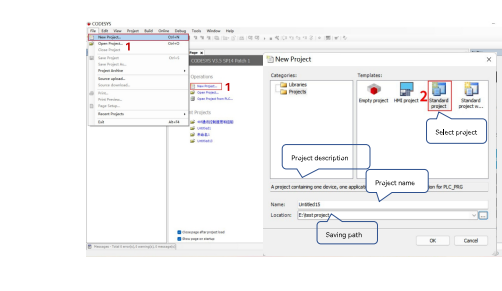
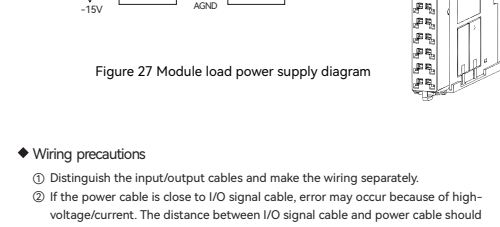

Remove the cable from the square socket. Apply a force of more than 10N.

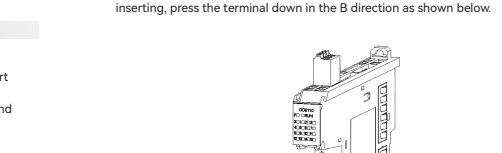
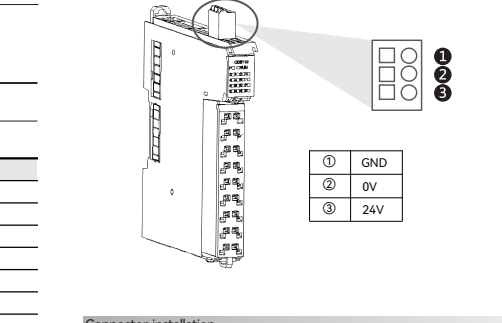

Insert the qualified cable to another square wiring socket. Apply a force of more than 10N.

