

Foreword

Thank you for choosing the Flextronics SD500 series spindle servo driver!

SD500 series spindle driver adopts high-performance closed-loop vector control, which has the characteristics of wide speed range, fast response, accurate positioning, etc. The rich functions and external expansion interface can cooperate with the higher-level CNC system to easily realize the spindle ready to stop, C axis, and rigid tapping, Indexing and positioning needs. SD500 series spindle driver can be widely used in machining centers, CNC machine tools, CNC milling machines, slant lathes and other equipment, as well as flying shears, cutting and other fields. It is the preferred drive product for various machine tool power shafts.

This manual is the user manual of SD500 spindle servo driver. It provides product safety information, mechanical and electrical installation instructions, basic debugging, troubleshooting and troubleshooting, and routine maintenance related matters. In order to ensure that the SD500 spindle servo driver can be correctly installed and operated and its superior performance can be exerted, please read this manual carefully before installation. If you have any doubts about some functions and performance, please consult our technical support personnel for help.

Due to the continuous improvement of servo products, the information provided by our company is subject to change without notice.

contents

FOREWORD	I
CHAPTER 1 OVERVIEW	1
1.1 SAFETY PRECAUTIONS	1
1.2 BEFORE USE	2
1.3 TECHNICAL SPECIFICATIONS	4
CHAPTER 2 MECHANICAL AND ELECTRICAL INSTALLATION	7
2.1 MECHANICAL INSTALLATION	7
2.2 ELECTRICAL INSTALLATION.....	10
CHAPTER 3 KEYBOARD LAYOUT AND OPERATION INSTRUCTIONS	23
4.1 PARAMETER ICON DESCRIPTION	26
4.2 PARAMETER LIST	26
4.3 GROUP F00: ENVIRONMENTAL APPLICATIONS	28
4.4 F01 GROUP : BASIC SETTING	28
4.5 F02 GROUP : MOTOR 1 PARAMETER	35
4.6 F03 GROUP : VECTOR CONTROL	42
4.7 F04 GROUP : V/F CONTROL.....	49
4.8 F05 GROUP : INPUT TERMINAL.....	52
4.9 F06 GROUP : OUTPUT TERMINAL.....	60
CHAPTER5 THE APPLICATION GUIDANCE OF SPINDLE FUNCTIONS	115
5.1 MOTER SELF-LEARNING.....	115
5.2 FORWARD AND REVERSE IN SPEED MODE	119
5.3 PULSE POSITION MODE	123

5.4 SPINDLE READY TO STOP	126
5.5 EXPLANATION OF COMMON FAULTS AND MATCHING PROBLEMS.....	128
CHAPTER 6 INSPECTION, MAINTENANCE AND WARRANTY	134
6.1 INSPECTION	134
6.2 MAINTENANCE.....	135
6.3 PRODUCT WARRANTY	135
APPENDIX.....	136
APPENDIX1 : MODBUS PROTOCOL.....	136
APPENDIX2 : TERMINAL WIRING.....	138



Chapter 1 Overview

1.1 Safety precautions

In order to ensure the safe and reasonable use of this product, please fully understand the safety precautions described in this manual before using this product.

Warning signs and their meanings

The following marks are used in this manual to indicate that they are important for safety. Failure to follow these precautions could result in personal injury or death, and damage to the product and associated systems.

 DANGER	DANGER: Failure to do so may result in death or serious safety accident.
 CAUTION	CAUTION: Misoperation may cause minor injuries.

Operational qualification

This product must be operated by trained professionals. In addition, operators must be trained in professional skills, familiar with the installation, wiring, operation and maintenance of the equipment, and properly respond to various emergencies in use.

Safety guidance

Warning signs are proposed for your safety and are measures taken to prevent injury to operators and damage to the product and associated systems; please read this manual carefully before use, and strictly follow the safety rules and warnings in this manual Flag to operate.

- Proper transportation, storage, installation, and careful operation and maintenance are essential to the safe operation of the spindle drive. During transportation and storage, it is necessary to ensure that the spindle drive is not subject to shock and vibration. It must also be stored in a dry, non-corrosive gas, non-conductive dust, and ambient temperature lower than 60 ° C.
- This product has dangerous voltage, and it controls the motion mechanism with potential danger. If you do not follow the regulations or operate in accordance with the requirements of this manual, it may cause personal injury and death, and damage to the product and related systems.
- Do not perform wiring work when the power is on, otherwise there is a danger of death due to electric shock; during wiring, inspection, maintenance, etc., please cut off the power of all related equipment, and confirm that the DC voltage of the main circuit has dropped to Safety level, wait 5 minutes before performing related operations.
- The power cables, motor cables, and control cables must be tightly connected. The ground terminals must be reliably grounded and the ground resistance must be less than 10 Ω .
- The static electricity of the human body will seriously damage the internal sensitive devices. Before performing related operations, please observe the measures and methods prescribed by the electrostatic discharge prevention measures (ESD), otherwise the spindle drive may be damaged.
- Since the output voltage of the spindle drive is a pulse waveform, if a capacitor to improve power factor or a varistor for lightning protection is installed on the output side, be sure to remove or modify it on the input side of the spindle drive.

- Do not add switching devices such as circuit breakers and contactors on the output side of the spindle drive (if a switching device must be connected on the output side, the control must ensure that the output current of the spindle drive is zero when the switch is operating).
- No matter where the fault occurs in the control equipment, it may cause production shutdown and major accidents. Therefore, please take necessary external protective measures or backup devices.
- This product can only be used for the purpose specified by the manufacturer. It must not be used in special areas such as emergency, rescue, marine, medical, aviation, nuclear facilities without permission.
- The maintenance of this product can only be performed by the company or professionals authorized by the company. Unauthorized modification and use of accessories not approved by the company may cause product failure. During maintenance, any defective device must be replaced in time.
- Our company does not take any responsibility for injuries and equipment damage caused by your company or your customers' failure to comply with the contents of this instruction manual.

1.2 Before use

After receiving the product, you ordered, please check the outer package for damage, open the outer package after confirming the integrity, and confirm whether the spindle driver is damaged, scratched or dirt (the damage caused by the product transportation is not included in the "three guarantees" of our company range). If the product you received has been damaged during shipping, please contact us or the shipping company immediately. After confirming that the received product is intact, please confirm whether the model of the received spindle drive is the same as the product you ordered.

1.2.1 Spindle servo drive model and nameplate description

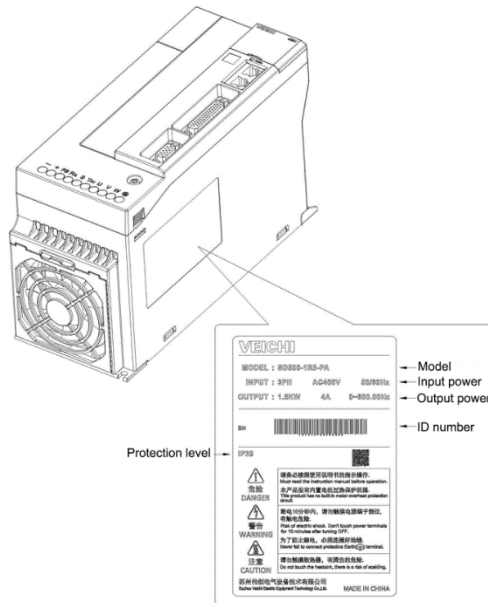

SD 500 - 5R5 D - P B

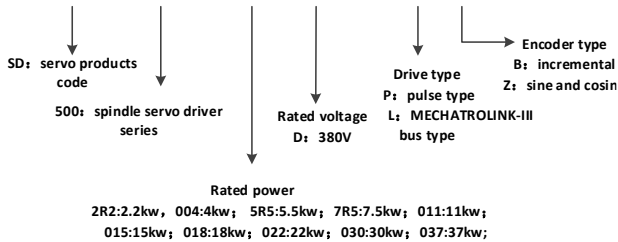

Rated output current of spindle servo driver

Input voltage	380V		
Spindle driver model	Rated input current (A)	Rated output current (A)	Adapted motor power (kw)
SD500-004D-PB	12.0	10.0	4.0
SD500-5R5D-PB	14.6	13.0	5.5
SD500-7R5D-PB	21.5	17.0	7.5
SD500-011D-PB	27.0	25.0	11.0

SD500-015D-PB	35.2	32.0	15.0
SD500-018D-PB	45.3	38.0	18.0
SD500-022D-PB	50.0	45.0	22.0
SD500-030D-PB	67.7	60.0	30.0
SD500-037D-PB	83.4	75.0	37.0

1.2.2 Motor Nomenclature

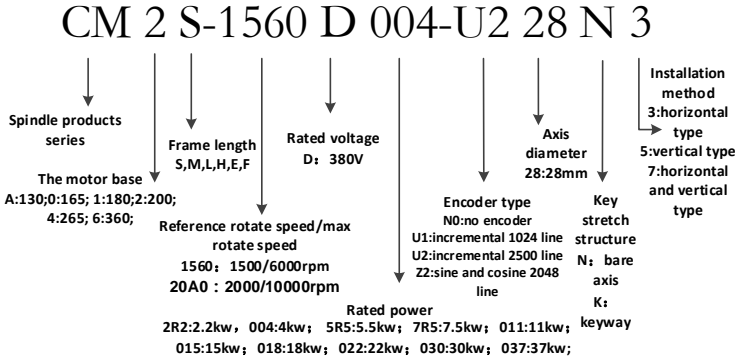

1.3 Technical specifications

project		description
power input	Voltage frequency	Three-phase: 380V ~ 440V, 50 / 60Hz
	Allow fluctuations	Voltage imbalance rate: <3%; Frequency: ± 5%; Distortion rate meets the requirements of IEC61800-2
	Closing impulse current	Less than rated current
	Power factor	≥0.94 (with DC reactor)
	Spindle drive efficiency	≥96%
Output	The output voltage	Output under rated conditions: three-phase 380 ~ 440V, error is less than 5%
	Output speed range	4-pole motor 0 ~ 18000rpm; 0 ~ 600Hz
Main control	Motor control mode	Sine wave PWM modulation, full closed loop vector control

SD500spindle servo driver

performance	Speed control range	1: 1000
	Steady speed accuracy	≤0.05% rated synchronous speed
	Starting torque	200% rated torque at 0Hz
	Torque response	<10ms
	Speed control accuracy	± 0.2%
	Position control accuracy	± 1pulse
	Overload capacity	200% rated current 20S
I/O interface	Digital input	7 optocoupler isolated inputs, input methods NPN, PNP are optional.
	Digital output	2 optocoupler isolated outputs
	Analog input	2 channels: -10V ~ + 10V, 0 ~ 10V, 0 ~ 20mA optional
	Analog output	1 way: 0 ~ 10V, 0 ~ 20mA optional
	Relay output	2 way: two sets of normally open and normally closed contacts
	Encoder input interface	2 channels: 1 motor encoder; 1 spindle encoder
	Encoder output interface	1 way: frequency division output
	Pulse input interface	1 way: orthogonal pulse / direction + pulse / CW + CCW
	Bus interface	None
Spindle function	speed control	Range: 0 ~ 12000RPM;
	Ready to stop control	± 1pulse accuracy; 8 positions can be selected with
	Rigid tapping	Can interface with a variety of imported domestic systems, tapping error 2%
	Encoder self-learning	Dual encoders automatically learn directions without adjusting wiring
	Zero point and one key setting	One point to set any position to zero
	Arbitrary frequency division output	1 ~ 32767 arbitrary frequency division output selection
	other functions	C-axis control, thread cutting, electronic gear, reaming, zero

Protective function		Over-voltage, under-voltage, current limit, over-current, overload, electronic thermal relay, over-temperature, over-voltage stall, data protection, rapid protection, input and
surroundings	Installation site	Altitude is lower than 1000 meters, derating for use above 1000 meters, derating 1% for every 100 meters; No condensation, icing, rain, snow, hail, etc., solar radiation
	temperature humidity	-10 ~ + 50 °C, derating above 40 °C, maximum temperature 60 °C (no-load operation)
	vibration	9~200Hz, 5.9m/s ² (0.6g)
	Storage temperature	-30~+60°C
	Installation method	Wall-mounted, vertical cabinet
	Protection class	IP20
	cooling method	Forced air cooling

Chapter 2 Mechanical and Electrical Installation

In order to ensure the safe use of the product by the user, maximize the performance of the spindle drive, and ensure the reliable operation of the spindle drive, please use this product strictly in accordance with the environmental, wiring, and ventilation requirements described in this chapter.

2.1 Mechanical installation

2.1.1 Dimensions of spindle drive

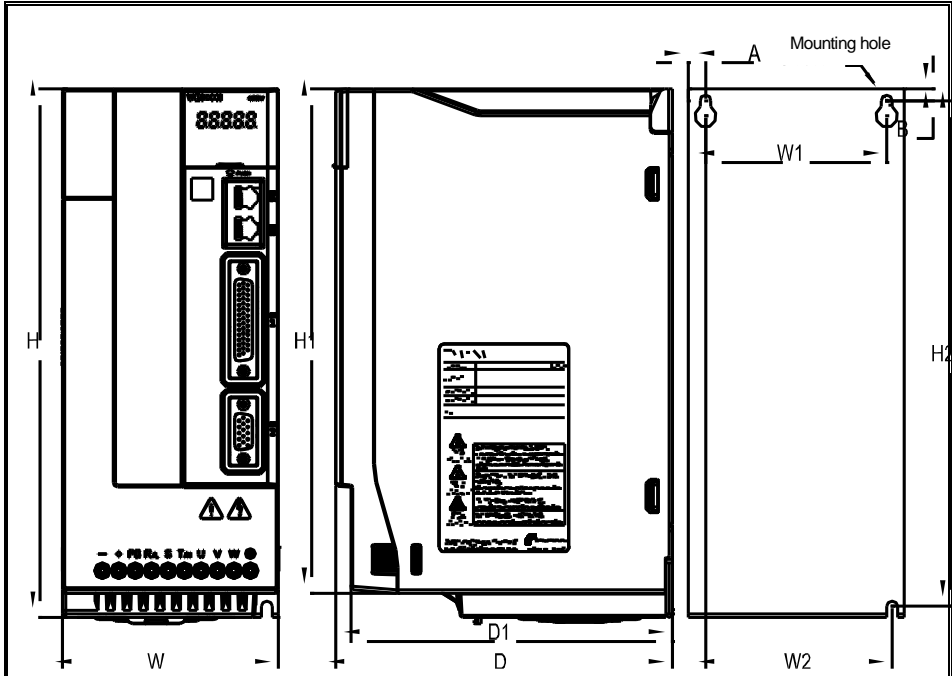

Spindle driver model	Dimensions (mm)					Installation size (mm)					Mounting aperture
	W	H	H1	D	D1	W1	W2	H2	A	B	
SD500-	100	242	231	156	149	84	86.5	231.5	8	5.5	3-M4
SD500-											
SD500-	116	320	307.5	176	169	98	100	307.5	9	6	3-M5
SD500-											

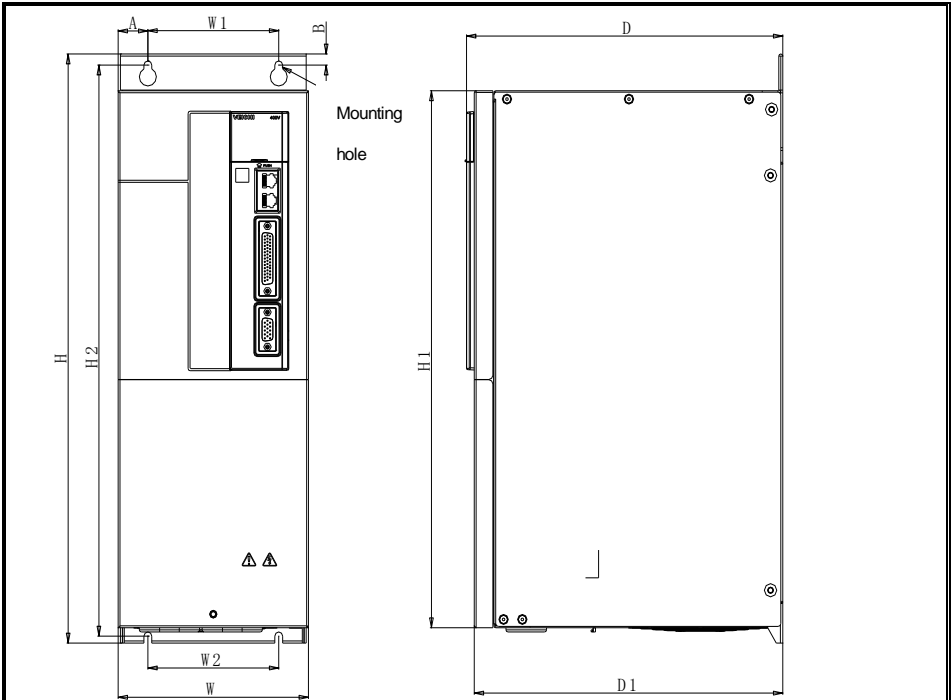

Spindle driver model	Dimensions (mm)					Installation size (mm)					Mounting aperture
	W	H	H1	D	D1	W1	W2	H2	A	B	
SD500 - SD500-018D-*	145	424.5	387	242	236	100	100	411.5	23	8	4-M5
SD500- SD500-	185	471	433	242	236	140	140	457	22	8.75	4-M6

2.1.2 Installation environment and precautions:

Ambient temperature: The ambient temperature has a great impact on the life of the spindle servo driver. The operating temperature of the spindle servo driver is not allowed to exceed the allowable temperature range (-10 °C ~ 50 °C), and the ambient temperature exceeds 40 °C, external forced cooling is required And the drive needs to be derated.

- The humidity in the installation site should be less than 95%, and no water condensation will occur. Avoid direct sunlight, oily, dusty or metal dust applications.

- If the altitude is over 1000m, the heat dissipation effect will be poor due to the thin air, so please derate it. The rated output decreases by 1% for every 100m increase in altitude.
- The main shaft driver must be installed on the surface of the flame retardant to ensure a sufficient heat dissipation space. The mounting surface must be able to reliably bear the weight of the spindle servo drive, otherwise there is a risk of personal injury or equipment damage from falling.
- When the spindle drive is installed near a vibration source, install anti-vibration devices on the mounting surface of the servo unit to prevent vibration from being transmitted to the servo unit.
- Install the spindle servo driver in a place far away from the source of electromagnetic interference.

2.1.3 Space requirements for spindle drive installation

The heat of the SD500 spindle servo driver is dissipated from the bottom up. The spindle servo driver must be installed in the following vertical manner. It is necessary to ensure that the SD500 spindle driver has sufficient cooling space. Please consider the heat dissipation of other components in the cabinet when you reserve space. When multiple spindle servo drives work, they are usually installed side by side. The installation space requirements are shown below. Where it is necessary to install the driver up and down, it is strongly recommended to install a thermal deflector between the drivers.

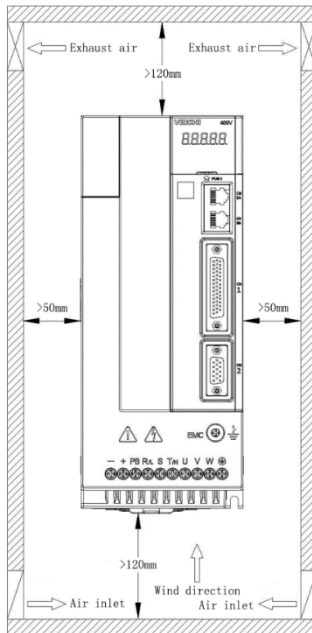

2.2 Electrical Installation

2.2.1 Peripheral electrical components and connections

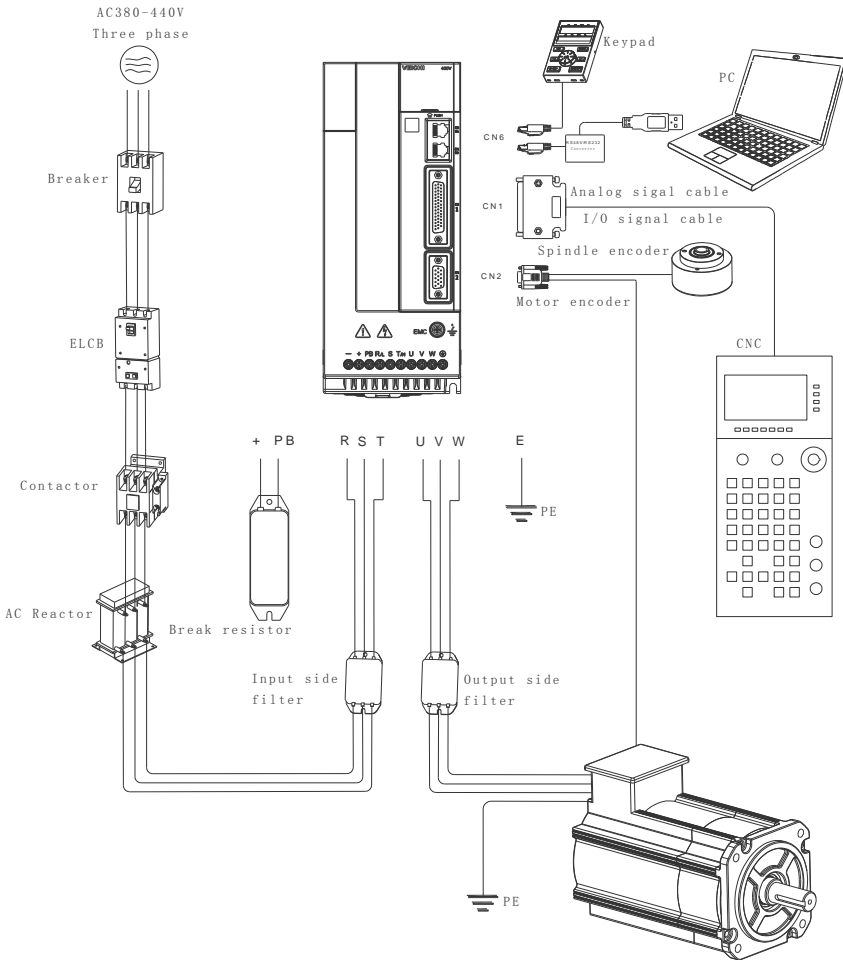

Note: When only one encoder is configured in the system, the spindle encoder signal terminal is invalid. The encoder signal must be connected to the motor encoder signal terminal.

2.2.2 Instructions for use of peripheral electrical components

Accessories name	Installation location	Function Description
------------------	-----------------------	----------------------

SD500spindle servo driver

air circuit breaker	Forefront of input circuit	act in time to protect when the downstream equipment is short-circuited or severely overloaded. The rated current of the air switch can be selected according to the rated current of the driver 150%.
Electromagnetic contactor	Between the circuit breaker and the spindle servo drive	Drive power control. Select according to the rated current of the driver 150%.
AC reactor	Input side of spindle servo driver	Increase the power factor on the input side; improve the overall efficiency and thermal stability of the spindle drive; Effectively eliminate the impact of the input side high harmonics on the spindle drive, and reduce external conduction and radiation interference. Select according to 100% of the rated current of the driver.
Braking resistor	11kW and below	11kW and below power models, please choose to use braking resistors, please refer to the braking resistor matching table for matching resistor The motor consumes regenerative energy through the braking resistor during deceleration.

- Selection of braking resistor

When the spindle drive is decelerated with a large inertia load or a sudden deceleration is required, the motor will work in the discharge state, and the load energy will be transmitted to the DC link of the spindle drive through the inverter bridge, causing the spindle drive bus voltage to rise. When it exceeds a certain limit, the drive will an overvoltage fault is reported. In order to prevent this phenomenon, an external braking component is required. The following table is a typical reference value for external braking resistor specifications:

Spindle driver model	Minimum allowable braking resistance	Braking resistor power
SD500-004D-PB	50Ω	1.0kw
SD500-5R5D-PB	50Ω	1.0kw
SD500-7R5D-PB	45Ω	1.5kw
SD500-011D-PB	35Ω	2.0kw
SD500-015D-PB	30Ω	3.0kw
SD500-018D-PB	30Ω	3.0kw
SD500-022D-PB	25Ω	4.0kw
SD500-030D-PB	18Ω	6.0kw

SD500spindle servo driver

SD500-037D-PB	18Ω	7.0kw
---------------	-----	-------

- The table is typical reference data. The selection of the braking resistor needs to be determined based on the power generated by the motor in the actual application system (but the braking resistance cannot be less than the above table limits). Energy and so on all matter. The larger the system's inertia, the shorter the deceleration time, and the more frequent the braking, the larger the braking resistor needs to choose the power and the smaller the resistance value. Users can choose different resistance value and power according to the actual situation. For detailed calculation, please consult our technical support

2.2.3 Main circuit terminal description

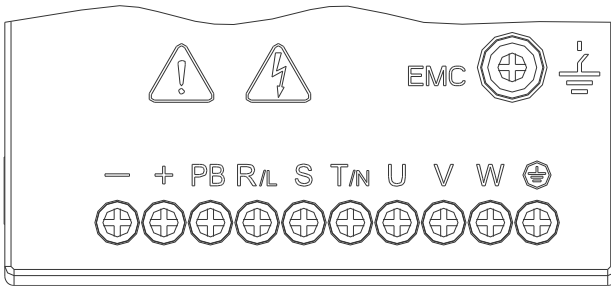

Terminal name silk screen	Terminal name	Function Description
R、S、T	Three-phase AC power input terminal, 380 ~ 440V, 50 / 60Hz	AC input three-phase power connection point.
(+), (-)	DC bus positive and negative terminals	Common DC bus input point or external braking unit.
(+), PB	Braking resistor connection terminal	External braking resistor reserved terminal.
U、V、W	Spindle servo driver output terminal	Three-phase AC output is connected to the motor.
PE	Ground terminal	Power and motor ground terminals.

- Recommended size of main circuit connection cable:

Servo Spindle driver model	Recommended cable size (mm ²)		Terminal screw specifications	Recommended tightening torque (N.m)
	R/S/T	U/V/W		
SD500-004D-PB	4.0	4.0	M4	1.2~1.5

SD500-5R5D-PB	6.0	6.0	M4	1.2~1.5
SD500-7R5D-PB	6.0	6.0	M5	2~2.5
SD500-011D-PB	10.0	10.0	M5	2~2.5
SD500-015D-PB	10.0	10.0	M6	4~6
SD500-018D-PB	16.0	16.0	M6	4~6
SD500-022D-PB	16.0	16.0	M6	4~6
SD500-030D-PB	25.0	25.0	M8	8~10
SD500-037D-PB	25.0	25.0	M8	8~10

Main circuit attention items:

- The input side wiring of the spindle servo driver has no phase sequence requirements. Pay attention to the electrical specifications of the power input.
- The specifications and installation methods of external power wiring must comply with local regulations and relevant IEC standards
- Refer to the recommended value for braking resistor selection and the wiring distance is less than 5m.
- Do not connect capacitors or surge absorbers to the output side of the spindle servo driver, otherwise the spindle servo driver will often be protected or even damaged.
- Route motor cables, input power cables, and control cables separately.

Please use the wire diameter specified by the technical standards of electrical equipment for the ground wire, and keep it as short as possible with the grounding resistance, and the grounding resistance should be less than 4Ω. The ground wire must not be shared with the welding machine or power equipment.

2.2.4 Control circuit wiring

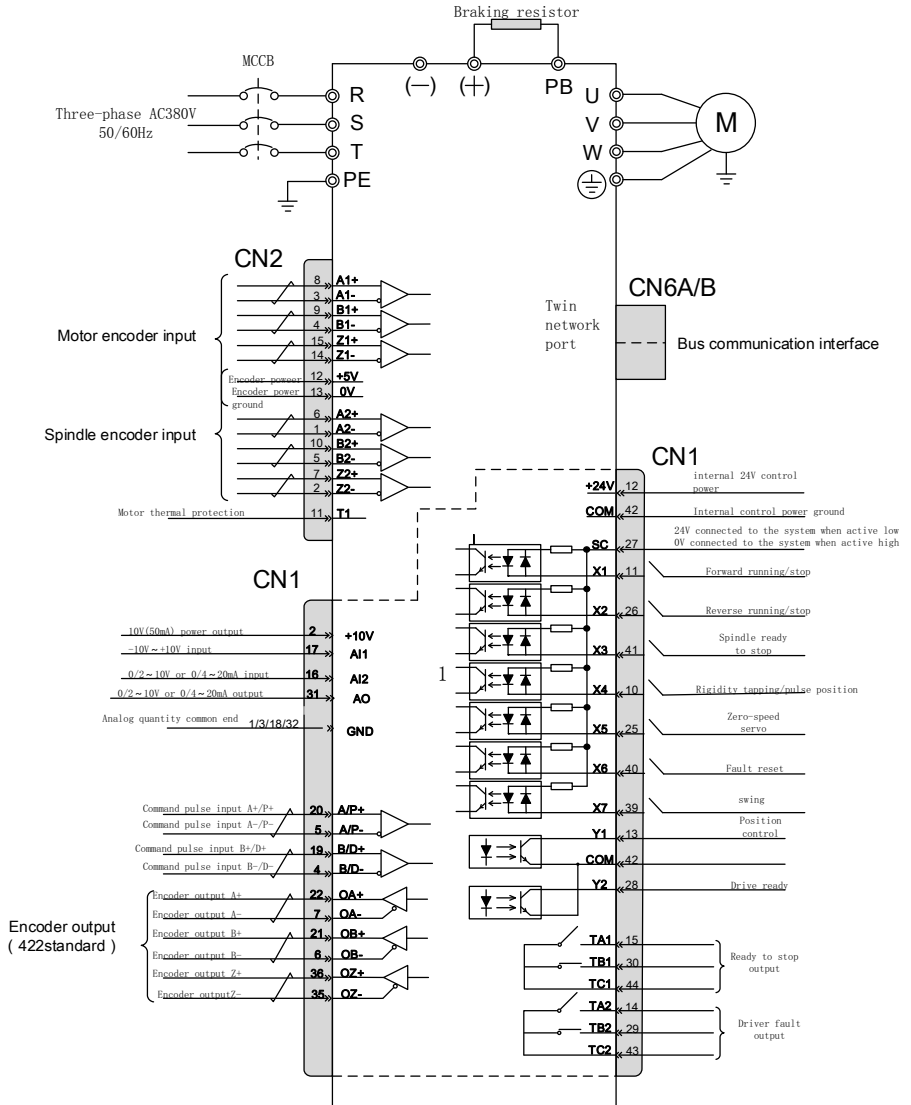

Note \neq Represents double twisted shield

● Control signal function description

kind	Terminal symbol	Terminal name	Terminal function definition
power supply	+5V-DGND	External + 5V power supply	Encoder power supply terminal, maximum output current of encoder power: 300mA
	+10V-GND	External + 10V power supply	Provide + 10V power to the outside, the maximum output current: 50 mA is generally used as the working power of an external potentiometer, the resistance value range of the potentiometer: 1K Ω ~ 5K Ω
	+24V-COM	External + 24V power supply	Provides + 24V power to the outside, which is generally used as the power supply for digital input and output terminals and the power supply for external sensors Maximum output current: 100 mA
Analog	AI1-GND	Voltage type analog input	1. Input range: AI1: -10V ~ + 10V input; AI2: 0 ~ 10V / 0 ~ 20mA input. The default voltage type input can be selected through function code P05.42. 2. Input impedance: 20k Ω for voltage input and 500 Ω for current input.
	AI2-GND	Voltage or current type analog input	
	AO-GND	Voltage or current type analog output	Output range: voltage 0 ~ + 10V or current 0 ~ 20mA. The default voltage type output can be selected through function code P06.00.
Digital input	X1、X2 X3、X4 X5、X6 X7、SC	Digital input, high-speed input	1. Input impedance: 4.4 K Ω 2. Voltage range when level input: 10 ~ 30V 3. This terminal is a bi-directional input terminal and supports both NPN and PNP connection. 4. In addition to X1 ~ X6, X7 can also be used as a high-speed pulse input channel. The highest input frequency: 100kHz. 5. All are programmable digital input terminals. Users can set terminal functions through function

			codes.
	A+/A- B+/B- Z+/Z-	Spindle incremental encoder input	Only accepts RS-485 standard differential signal transmitter signals
	PULS+/PULS- SIGN+/SIGN-	Position command signal	Only accepts RS-485 standard differential signal transmitter signals
Digital output	Y1+/COM Y2+/COM	Digital output 1, 2	Optocoupler isolation, open collector output 1. Output voltage range: DC 0V ~ 30V 2. Output current range: DC 0mA ~ 50mA
	TA1/TB1/TC1 TA2/TB2/TC2	Relay output 1, 2	TA1-TC1 / TA2-TC2: normally open; TB1-TC1 / TB2-TC2: normally closed Contact capacity: 30VDC / 1A
	OA+/OA- OB+/OB- OZ+/OZ-	Encoder divided output	Differential output, the receiver needs to use RS-485 standard differential signal receiver

2.2.5 Terminal pin definition

- CN1 multi-function control terminal pin definition:

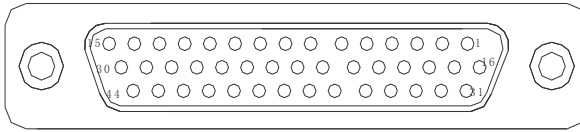

CN1 multifunctional terminal interface

Pin number	Signal name	Features	Pin number	Signal name	Features
1	AGND	Analog GND	23		
2	10V+	Internal 10V, 100mA	24		
3	AGND	Analog GND	25	X5	Multi-function contact input 5
4	SIGN-	Command direction-	26	X2	Multi-function contact input 2
5	PULS-	Pulse command-	27	SC	I / O common terminal +
6	OB-	Divided output OB-	28	Y2+	Open collector output 2+
7	OA-	Divided output OA-	29	TB2	Relay B2
8			30	TB1	Relay B1
9			31	AO1	0 ~ 10V, 0 ~ 20mA optional
10	X4	Multi-function contact input 4	32	AGND	Analog GND
11	X1	Multi-function contact input 1	33	DGND	Digital GND
12	24V+	Internal 24V, 100mA	34	DGND	Digital GND
13	Y1+	Open collector output 1+	35	OZ-	Divided output OZ-
14	TA2	Relay A2	36	OZ+	Divided output OZ+
15	TA1	Relay A1	37		
16	AI2	0~10V、0~20mA Optional	38		
17	AI1	-10V~+10V	39	X7	Multi-function contact input7
18	AGND	Analog GND	40	X6	Multi-function contact input6

SD500spindle servo driver

19	SIGN+	Command direction +	41	X3	Multi-function contact input3
20	PULS+	Pulse command +	42	COM	Internal + 24V power ground
21	OB+	Divided output OB +	43	TC2	RelayC2
22	OA+	Divided output OA +	44	TC1	RelayC1

● CN2 Encoder terminal pin definition:

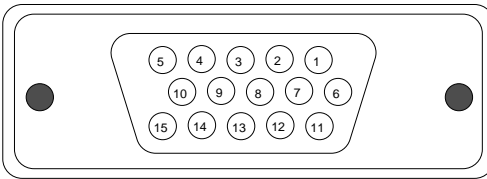

CN2 encoder interface					
Pin number	Signal name	Features	Pin number	Signal name	Features
1	U-	Spindle encoder signal A-	8	A+	Motor encoder signal A+
2	W-	Spindle encoder signal Z-	9	B+	Motor encoder signal B+
3	A-	Motor encoder signal A-	10	V+	Spindle encoder signalB+
4	B-	Motor encoder signal B-	11	T1	Motor overheating
5	V-	Spindle encoder signalB-	12	5V	Motor encoder power 5V
6	U+	Spindle encoder signalA+	13	0V	Motor encoder power 0V
7	W+	Spindle encoder signalZ+	14	Z-	Motor encoder signal Z-

SD500spindle servo driver

shell	shield	-	15	Z+	Motor encoder signal Z+
-------	--------	---	----	----	-------------------------

Note: When only one encoder is configured in the system, the Spindle encoder signal terminal is invalid. You must connect the encoder signal to the Motor encoder signal terminal.

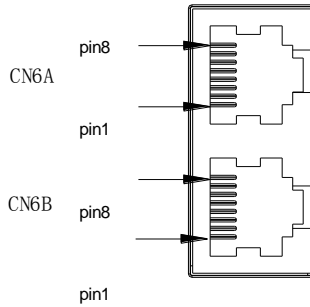

- CN6 network port terminal pin definition:

CN6A / CN6B interface definition

Pin number	Signal name	Features	Pin number	Signal name	Features
1	GND	Signal ground	6	-	-
2	-	-	7	485-	485 data -
3	GND	Signal ground	8	485+	485 data +
4	+5V	External keyboard	shell	shield	shield
5	+5V	power			

2.2.6 Control circuit wiring instructions

- AI Analog input circuit:
- SD500 spindle servo provides two analog input interfaces AI1 (-10 ~ +10V) and AI2 (0 ~ +10V or 0 ~ 20mA).
Because weak analog signals are susceptible to external interference, the control cables should be kept far away from the main circuit and high-current lines (including power lines, motor lines, relays, contactor connection lines, etc.) more than 30cm when wiring, and avoid parallel placement. It is strongly recommended to use twisted-pair shield cable for the connection line. The shield layer of the cable should be reliably connected to the driver terminal shell, and the wiring distance should be as short as possible. In some occasions where the analog signal is severely disturbed, a ferrite ring can be added near the driver. The following figure is the wiring diagram of the analog input terminal:

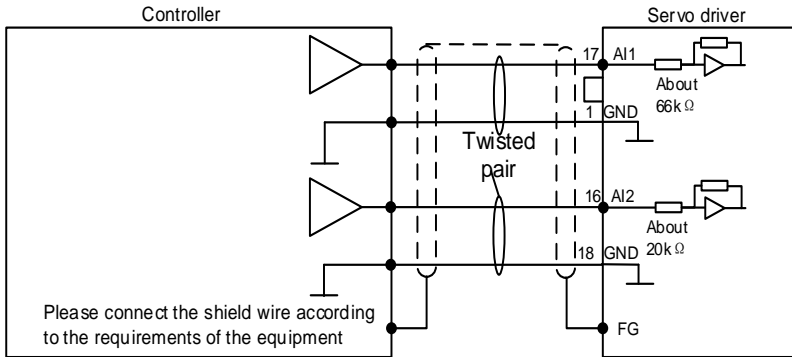

● digital input terminal wiring:

The digital input terminals X1 ~ X7 support sink or source wiring. The following uses X1 as an example to explain, X1 ~ X7 interface circuits are the same. The following is an example of wiring by relay and transistor circuit (sink or source wiring). When using a relay connection, select a relay for minute current. If the relay for minute current is not used, it will cause poor contact.

a) Leakage wiring

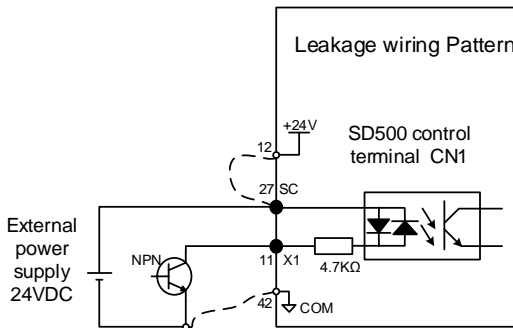

b) Source wiring

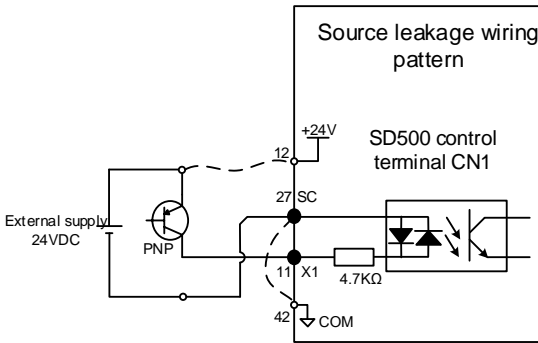

c) Relay wiring

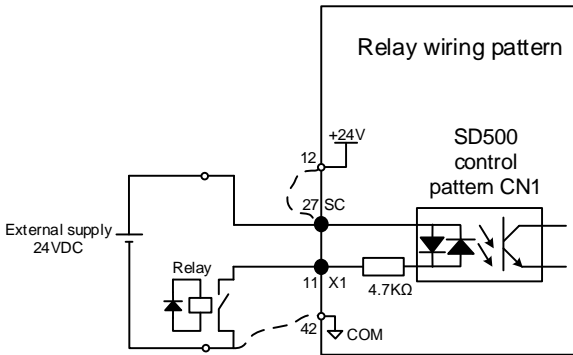

Note:

1. The above examples are powered by external power supply. If using the internal power supply of the driver, please connect according to the dotted line in the figure.
2. The external power supply (DC24V) must have a capacity of more than 50mA.
3. It does not support the mixed use of NPN and PNP input methods.

- Digital output terminal wiring

Taking Y1 as an example, the Y1 / Y2 circuit interface circuit is the same.

The following figure shows the connection example when the upper receiving device is an optocoupler and a relay:

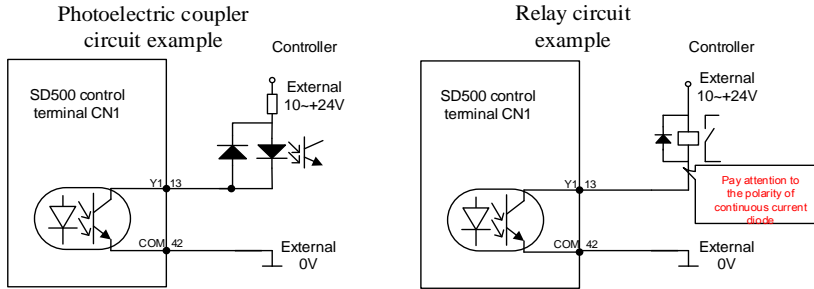

Note:

1. When the digital output terminal needs to drive the relay, install absorption diodes on both sides of the relay coil, and the diode polarity must be installed correctly, otherwise the equipment will be damaged.
 2. The maximum allowable voltage of open collector output circuit is DC30V and the maximum allowable current is DC20mA
- .2.2.7 Countermeasures against noise and higher harmonics

The following describes countermeasures against noise and harmonics.



This servo unit has a built-in microprocessor. Therefore, it may be affected by noise from its peripheral equipment. In order to prevent mutual noise interference between the servo unit and its peripheral equipment, the following countermeasures against noise interference can be taken as required.

- Install the input command equipment and noise filter as close to the servo unit as possible.
- Be sure to connect a surge suppressor to the coils of the relay, solenoid, and magnetic contactor.
- Do not use the same sleeve for the main circuit cable and the input / output signal cable / encoder cable, and do not bundle them together. When wiring, keep the main circuit cable and the input / output signal cable / encoder cable at least 30cm away.
- Do not use the same power source as electric welding machines, electric discharge machines, etc. Even if the power is not the same, when there is a high-frequency generator nearby, please connect a noise filter to the input side of the main circuit power cable and control power cable.

Chapter 3 Keyboard Layout and Operation

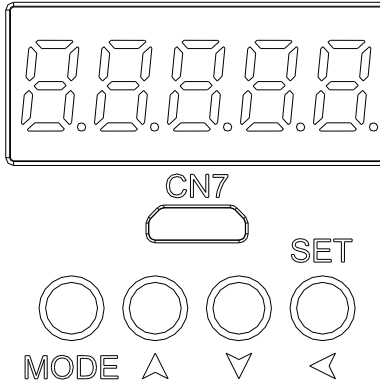
Instructions



Integrated keyboard	Features
Menu MODE	When in standby or running, enter the Features menu interface; when the parameter is modified, press this key to exit the modification; when in standby or running, press and hold the key (1
Confirm / shift key SET 	Confirm Features: Press this key to confirm the modified value after modifying the value Shift Features: Long press this key to move the operation bit, long
Upper key, lower key  	Value modification: Up key increases the operation value, down key decreases the operation value Fault reset: press the up and down keys simultaneously to enable fault reset

- Basic parameter group parameter setting

The following takes F1.22 [Acceleration time] = 10.00s as an example to explain the basic operation of the LED operator.

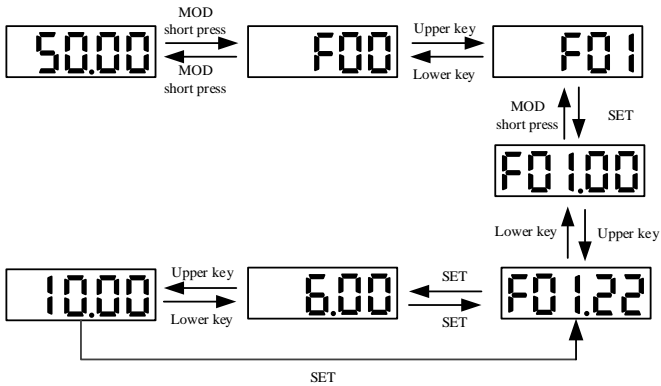

Note: When modifying the tens, hundreds, and thousands of parameter values, use the keyboard shift key Features to quickly select them.

- Operation monitoring status check

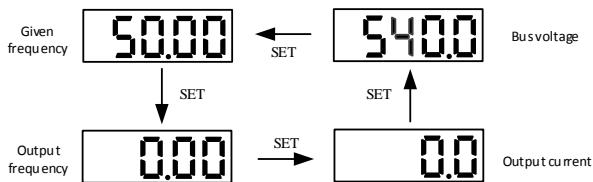

Note: When using an external keyboard, use the left button to cycle through the first line of monitoring parameters, and use the right button to cycle through the second line of monitoring parameters.

- Monitoring parameter view

The following uses C02.05 [PLC operation stage] as an example to explain the basic operation of the LED operator.

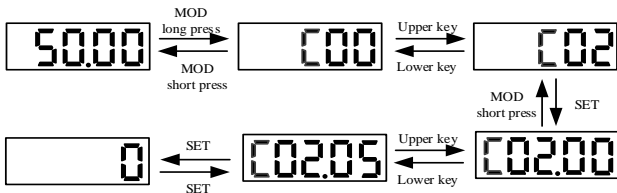

- Motor self-learning

In order to obtain the best control effect, the motor operating system parameters need to be self-learned under vector control. Refer to the following figure for the self-learning enable process. Please select rotary self-learning for the first time self-learning. During the self-learning process, please ensure that the motor is in no load or light load state.

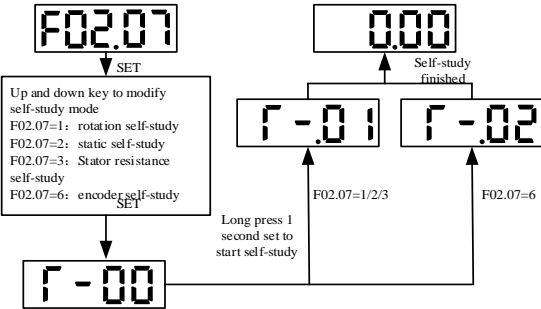

Chapter 4 Summary of Parameters

4.1 Parameter icon description

◆ Icons and terminology for control mode

icon	content
V/F	Valid parameters in V / F control mode
SVC	Effective parameters under open loop vector control
FVC	Effective parameters under closed-loop vector control
PMVF	Valid parameters in synchronous motor V / F control mode
PMSVC	Valid parameters in synchronous motor open-loop vector control mode
PMFVC	Valid parameters in synchronous motor closed-loop vector control mode

Note: The shading of the control mode icon indicates that the parameter is invalid in this control mode.

◆ Icons and terminology for control mode

icon	content
RUN	Parameters that can be modified during operation
STOP	Parameters that cannot be modified during operation
READ	This parameter can only be read and cannot be modified (when modified, LED displays 5 "-")

4.2 Parameter list

◆ Indicates the type of product parameters

parameter	name	parameter	name
F00.0x	Environment settings	F07.1x	Shutdown control
F00.1x	Common parameter settings	F07.2x	DC braking and speed tracking
F01.0x	Basic instructions	F07.3x	Jog
F01.1x	Frequency command	F07.4x	Start and stop frequency maintenance and frequency jump
F01.2x	Acceleration and deceleration time	F08.0x	Counting and timing
F01.4x	PWM control	F08.3x	Swing frequency control
F02.0x	Motor basic parameters and self-learning options	F10.0x	Current protection
F02.1x	Advanced parameter of asynchronous motor	F10.1x	Voltage protection

SD500spindle servo driver

F02.5x	Motor application parameter	F10.2x	Auxiliary protection
F03.0x	Speed loop	F10.3x	Load protection
F03.1x	Current loop and torque limit	F10.4x	Stall protection
F03.2x	Torque optimization control	F10.5x	Failure recovery protection
F03.3x	Flux optimization	F11.0x	Key operation
F03.4x	Torque control	F11.1x	Status interface cyclic monitoring
F04.0x	V / F control	F11.2x	Monitoring parameter control
F04.1x	Custom V / F curve	F11.3x	Keyboard Special Features
F04.3x	V / F energy saving control	F12.0x	MODBUS slave parameter
F05.0x	Digital input terminal	F12.1x	MODBUS host parameter
F05.1x	X1-X4 detection delay	F13.00-F13.06	PID setting and feedback
F05.2x	Digital input terminal action selection	F13.07-F13.24	PID adjustment
F05.3x	PUL terminal	F13.25-F13.28	PID feedback disconnection judgment
F05.4x	Analog type processing	F13.29-F13.33	Sleeping Features
F05.5x	Analog linear processing	F14.00-F14.14	Multi-speed frequency reference
F05.6x	AI curve 1 processing	F14.15	PLC operation mode selection
F05.7x	AI curve 2 processing	F14.16-F14.30	PLC running time selection
F05.8x	AI as digital input terminal	F14.31-F14.45	PLC direction and acceleration / deceleration time selection
F06.0x	AO output	F15.xx	Position control parameter
F06.2x	Digital, Relay output	F24.xx	Spindle-specific parameter
F06.4x	Frequency detection	C00.0x	Basic monitoring
F06.5x	Monitor parameter comparator output	C01.0x	Fault monitoring
F06.6x	Virtual input and output terminals	C04.xx	Spindle feedback monitoring
F07.0x	Start control	C05.xx	Position control monitoring

4.3 Group F00: Environmental applications

F00.0x group: environment setting

parameter code (address)		name	content	Factory default (Predetermined area)	Adjustable properties
F00.00 (0x0000)		parameter access level	<p>V/F SVC FVC PMVF PMSVC PMFVC</p> <p>Set the parameter access level according to the condition that parameter access is restricted.</p> <p>0: standard parameter (Fxx.yy) 1: common parameter (F00.00, Pxx.yy) 2: monitoring parameter (F00.00, Cxx.yy) 3: changed parameter (F00.00, Hxx.yy)</p>	0 (0~3)	RUN
F00.03 (0x0003)		initialization	<p>V/F SVC FVC PMVF PMSVC PMFVC</p> <p>Set the spindle drive initialization method.</p> <p>0: Do not initialize 11: Select the setting value for the parameter according to the purpose (excluding the motor parameter) 22: Initialization of all parameters 33: Clear fault record</p>	0 (0~33)	STOP
F00.04 (0x0004)		Keyboard parameter copy	<p>V/F SVC FVC PMVF PMSVC PMFVC</p> <p>0: No Features 11: upload parameter to keyboard</p>	0 (0~9999)	STOP

			22: Download parameter to the spindle drive		
F00.05 (0x0005)	user password		V/F SVC FVC PMVF PMSVC PMFVC Used to set user password.	0 (0~65355)	STOP
F00.06 (0x0006)	LCD keyboard language selection		V/F SVC FVC PMVF PMSVC PMFVC Select the language displayed on the LCD operator. 0: Chinese 1: English	0 (0~1)	RUN
F00.07 (0x0007)	Free parameter1		V/F SVC FVC PMVF PMSVC PMFVC When using multiple devices, as the device number or usage mode.	0 (0~65535)	RUN
F00.08 (0x0008)	Free parameter2		V/F SVC FVC PMVF PMSVC PMFVC When using multiple devices, use the device number or application mode number.	0 (0~65535)	RUN

F00.1x group: common parameter setting

parameter code (address)	name	content	Factory default (Predetermined area)	Adjustable properties
F00.10~ F00.39 (0x0010~ 0x0027)	Common parameter address settings	V/F SVC FVC PMVF PMSVC PMFVC Tens place digits: yy setting in Featuresparameter number Fxx.yy 00 ~ 99 Hundreds and Thousands: xx setting in Featuresparameter number Fxx.yy 00 ~ 31	0102 (0000~2363)	RUN

4.4 F01 Group : Basic Setting

F01.0x Group : Basic Command

Parameter code (Address)	Name	Description	Factory value (Setting range)	Adjustable attribute
F01.00 (0x0100)	Motor 1 control mode	<p>V/F SVC FVC PMVF PMSVC PMFVC</p> <p>Motor control mode</p> <p>0: AM-VF: VF control</p> <p>1: AM-SVC: VC without PG, current closed loop control</p> <p>2: AM-FVC: VC with PG</p> <p>10: PM-VF: VF control</p> <p>11: PM-SVC: VC without PG</p> <p>12: PM-FVC: VC with PG</p>	2 (0~12)	STOP
F01.01 (0x0101)	Run command channel	<p>V/F SVC FVC PMVF PMSVC PMFVC</p> <p>It is used to select the channel for the spindle drive to accept the operation and stop commands and the operation direction</p>	1 (0~3)	RUN
F01.02 (0x0102)	Frequency given source channel A	<p>V/F SVC FVC PMVF PMSVC PMFVC</p> <p>Setting frequency of spindle drive as Given source A</p> <p>0: keyboard number given</p> <p>1: Keyboard analog potentiometer given</p> <p>2: Voltage analog AI1 given</p> <p>3: Current/Voltage analog AI2 given</p> <p>4: Reserved</p> <p>5: Terminal pulse PUL given</p> <p>6: RS485 communication given</p> <p>7: Terminal UP/DW control given</p> <p>8: PID control give</p> <p>9: Program control(PLC) given</p>	10 (0~11)	RUN

SD500spindle servo driver

		10: Positioning pulse terminal given 11: Multi-steps speed given		
F01.03 (0x0103)	Frequency given source channel A gain	V/F SVC FVC PMVF PMSVC PMFVC Gain of frequency given source channel A	100.0 (0.0~ 500.0%)	STOP
F01.04 (0x0104)	Frequency given source channel B	V/F SVC FVC PMVF PMSVC PMFVC Setting frequency of spindle drive as Given source B,same as [F01.02]	2 (0~11)	RUN
F01.05 (0x0105)	Frequency given source channel B gain	V/F SVC FVC PMVF PMSVC PMFVC Gain of frequency given source channel B	100.0 (0.0~ 500.0%)	STOP
F01.06 (0x0106)	Frequency channel B reference source	V/F SVC FVC PMVF PMSVC PMFVC Frequency channel B reference source 0: the Max output frequency as the reference source 1: Take A set frequency as reference source	0 (0~1)	RUN
F01.07 (0x0107) STOP	Frequency given source selection	V/F SVC FVC PMVF PMSVC PMFVC Used to select the combination mode of frequency channel A and channel B set by the spindle drive. 0: Channel A 1: Channel B 2: Channel A + channel B 3: Channel A - channel B	0 (0~5)	RUN

<p>F01.08 (0x0108)</p>	<p>Run command binding given frequency</p>	<p>V/F SVC FVC PMVF PMSVC PMFVC</p> <p>When this parameter is valid, it is used to set the bundling frequency source channel of each running command channel</p> <p>LED "0" digit: Keyboard command binding LED "00" digit: Terminal command binding LED Hundre digit: Communication command binding LED Thousand digit: PG card command binding</p> <p>0: No binding 1: keyboard number given 2: Keyboard analog potentiometer given 3: Voltage analog AI1 given 4: Current/Voltage analog AI2 given 5: Reserved 6: Terminal pulse PUL given 7: Communication given 8: Terminal UP/ DW control given 9: PID control given A: Program control given B: Reserved C: Multi-steps speed given</p>	<p>0000 (0000~ DDDD)</p>	<p>RUN</p>
<p>F01.09 (0x0109)</p>	<p>Keyboard number given frequency</p>	<p>V/F SVC FVC PMVF PMSVC PMFVC</p> <p>Used to set and modify the frequency of keyboard number setting</p>	<p>50Hz (0.00~ Upper frequency setting)</p>	<p>RUN</p>

F01.1x Group : Frequency command

Parameter code (Address)	Name	Description	Factory value (Setting range)	Adjustable attribute
F01.10 (0x010A)	Maximum frequency	V/F SVC FVC PMVF PMSVC PMFVC The maximum frequency that the spindle drive can set	150.00Hz (Upper frequency~ 600.00Hz)	STOP
F01.11 (0x010B)	Upper frequency select	V/F SVC FVC PMVF PMSVC PMFVC Select the given source of the upper frequency for the spindle drive 0: Upper frequency number given 1: Keyboard analog potentiometer given 2: Current / voltage analog AI1 given 3: Current / voltage analog AI2 given 4: Reserved 5: Terminal pulse PUL given 6: RS485 communication given 7: PG card	0 (0~7)	RUN
F01.12 (0x010C)	Upper frequency digital setting	V/F SVC FVC PMVF PMSVC PMFVC The upper frequency given channel when F01.11 is set to 0	150.00Hz (0.00~ Maximum frequency digital setting)	RUN
F01.13 (0x010D)	Lower limit frequency	V/F SVC FVC PMVF PMSVC PMFVC Given the lower limit of frequency, limit the given frequency	0.00Hz (0.00~ Upper frequency digital	RUN

			setting)	
--	--	--	----------	--

F01.2x-F01.3x Group : Acceleration and deceleration time

Parameter code (Address)	Name	Description	Factory value (Setting range)	Adjustable attribute
F01.20 (0x0114)	ACC and DEC time reference	<p>V/F SVC FVC PMVF PMSVC PMFVC</p> <p>Set the reference frequency to calculate the acceleration and deceleration time.</p> <p>0: Maximum frequency 1: Fixed frequency 50Hz 2: Set frequency</p>	0 (0~2)	STOP
F01.21 (0x0115)	ACC time unit	<p>V/F SVC FVC PMVF PMSVC PMFVC</p> <p>Setting unit of acceleration time.</p> <p>0: 1S 1: 0.1S 2: 0.01S</p>	2 (0~2)	STOP
F01.22 (0x0116)	ACC time 1	<p>V/F SVC FVC PMVF PMSVC PMFVC</p> <p>The time required for the output frequency to accelerate from 0.00hz to the time reference frequency.</p> <p>1~6500s(F01.21 = 0) 0.1~6500.0s(F01.21 = 1) 0.01~650.00s(F01.21 = 2)</p>	Machine type setting (0.01~650.00s)	RUN
F01.23 (0x0117)	DEC time 1	<p>V/F SVC FVC PMVF PMSVC PMFVC</p> <p>The time required for the output frequency to decelerate from the time reference frequency to 0.00hz.</p>	Machine type setting (0.01~650.00s)	RUN

SD500spindle servo driver

F01.24 (0x0118)	ACC time 2	V/F SVC FVC PMVF PMSVC PMFVC The time required for the output frequency to accelerate from 0.00hz to the time reference frequency.	Machine type setting (0.01~650.00s)	RUN
F01.25 (0x0119)	DEC time 2	V/F SVC FVC PMVF PMSVC PMFVC The time required for the output frequency to decelerate from the time reference frequency to 0.00hz.	Machine type setting (0.01~650.00s)	RUN
F01.26 (0x011A)	ACC time 3	V/F SVC FVC PMVF PMSVC PMFVC The time required for the output frequency to accelerate from 0.00hz to the time reference frequency.	Machine type setting (0.01~650.00s)	RUN
F01.27 (0x011B)	DEC time 3	V/F SVC FVC PMVF PMSVC PMFVC The time required for the output frequency to decelerate from the time reference frequency to 0.00hz.	Machine type setting (0.01~650.00s)	RUN
F01.28 (0x011C)	ACC time 4	V/F SVC FVC PMVF PMSVC PMFVC The time required for the output frequency to accelerate from 0.00hz to the time reference frequency.	Machine type setting (0.01~650.00s)	RUN
F01.29 (0x011D)	DEC time 4	V/F SVC FVC PMVF PMSVC PMFVC The time required for the output frequency to decelerate from the time reference frequency to 0.00hz.	Machine type setting (0.01~650.00s)	RUN
F01.30 (0x011E)	S curve ACC and DEC selection	V/F SVC FVC PMVF PMSVC PMFVC Is the selection of acceleration and deceleration of S curve effective 0: invalid 1: valid	0 (0~1)	STOP
F01.31 (0x011F)	ACC start time for S-curve	V/F SVC FVC PMVF PMSVC PMFVC Set the acceleration start time for S-curve.	0.20s (0.00~10.00)	STOP

F01.32 (0x0120)	ACC end time for S-curve	V/F SVC FVC PMVF PMSVC PMFVC Set the acceleration end time for S-curve.	0.20s (0.00~10.00)	STOP
F01.33 (0x0121)	DEC start time for S-curve	V/F SVC FVC PMVF PMSVC PMFVC Set the deceleration start time for S-curve.	0.20s (0.00~10.00)	STOP
F01.34 (0x0122)	DEC end time for S-curve	V/F SVC FVC PMVF PMSVC PMFVC Set the deceleration end time for S-curve.	0.20s (0.00~10.00)	STOP
F01.35 (0x0123)	ACC time 1 and ACC time 2 switching frequency	V/F SVC FVC PMVF PMSVC PMFVC Set the switching frequency of acceleration time 1 and acceleration time 2.	0.00Hz (0.00~Maximum frequency digital setting)	RUN

F01.4x Group : PWM control

Parameter code (Address)	Name	Description	Factory value (Setting range)	Adjustable attribute
F01.40 (0x0128)	Carrier frequency	V/F SVC FVC PMVF PMSVC PMFVC It is used to set the switching frequency of IGBT of spindle driver.	Machine type setting (1.0~ 16.0kHz)	RUN
F01.41 (0x0129)	PWM control mode	V/F SVC FVC PMVF PMSVC PMFVC LED "0" digit: carrier associated with temperature 0: temperature independent 1: temperature related LED Ten digit: carrier associated with output frequency 0: independent of output frequency 1: related to output frequency LED Hundre digit: random PWM enable 0: disable 1: Enable LED Thousand digit: PWM modulation mode 0: only use three-phase modulation 1: two-phase three-phase modulation automatic switching	1101 (0000~ 1111)	RUN

F01.43 (0x012B)	Dead time compensation gain	V/F SVC FVC PMVF PMSVC PMFVC Gain of dead time compensation	Machine type setting (0~512)	RUN
--------------------	-----------------------------	--	---------------------------------	-----

4.5 F02 Group : Motor 1 parameter

F02.0x Group : Motor basic parameters and self-learning selection

Parameter code (Address)	Name	Description	Factory value (Setting range)	Adjustable attribute
F02.00 (0x0200)	Motor type	V/F SVC FVC PMVF PMSVC PMFVC Set the type of motor 0: asynchronous motor (AM) 1: permanent magnet synchronous motor (PM)	0 (0~1)	READ
F02.01 (0x0201)	Motor poles	V/F SVC FVC PMVF PMSVC PMFVC Set the number of motor poles.	4 (2~98)	STOP
F02.02 (0x0202)	Motor rated power	V/F SVC FVC PMVF PMSVC PMFVC Set the rated power of the motor.	Machine type setting (0.1~1000.0kW)	STOP
F02.03 (0x0203)	Motor rated frequency	V/F SVC FVC PMVF PMSVC PMFVC Set the rated frequency of the motor.	Machine type setting (0.01~最大频率)	STOP
F02.04 (0x0204)	Motor rated speed	V/F SVC FVC PMVF PMSVC PMFVC Set the rated speed of the motor.	Machine type setting (0~6500rpm)	STOP
F02.05 (0x0205)	Motor rated voltage	V/F SVC FVC PMVF PMSVC PMFVC Set the rated voltage of the motor.	Machine type setting (0~1500V)	STOP
F02.06 (0x0206)	Motor rated current	V/F SVC FVC PMVF PMSVC PMFVC Set the rated current of the motor.	Machine type setting	STOP

F02.07 (0x0207)	Motor parameter self-tuning select	<p>V/F SVC FVC PMVF PMSVC PMFVC</p> <p>The value of [F02.07] will be set to "0" automatically after the parameter is set</p> <p>0: no operation</p> <p>1: Static + rotation self-learning</p> <p>2: Static self-learning</p> <p>3: Stator resistance self-learning</p> <p>6: Rotation self-learning</p> <p>7: Inertia self-learning</p>	0 (0~7)	STOP
--------------------	---------------------------------------	---	------------	------

F02.1x Group : Advanced parameters of asynchronous motor

Parameter code (Address)	Name	Description	Factory value (Setting range)	Adjustable attribute
F02.10 (0x020A)	Asynchronous motor no-load current	<p>V/F SVC FVC PMVF PMSVC PMFVC</p> <p>Set the no-load current of asynchronous motor.</p>	Machine type setting (0.1~3000.0A)	STOP
F02.11 (0x020B)	Asynchronous motor stator resistance	<p>V/F SVC FVC PMVF PMSVC PMFVC</p> <p>Set the stator resistance of asynchronous motor.</p>	Machine type setting (0.01mΩ~60000mΩ)	STOP
F02.12 (0x020C)	Asynchronous motor rotor resistance	<p>V/F SVC FVC PMVF PMSVC PMFVC</p> <p>Set the rotor resistance of asynchronous motor.</p>	Machine type setting (0.01mΩ~60000mΩ)	STOP
F02.13 (0x020D)	Asynchronous motor stator leakage inductance	<p>V/F SVC FVC PMVF PMSVC PMFVC</p> <p>Set stator leakage inductance of asynchronous motor.</p>	Machine type setting (0.01mH~65535mH)	STOP

F02.14 (0x020E)	Asynchronous motor stator inductance	V/F SVC FVC PMVF PMSVC PMFVC Set induction motor stator inductance.	Machine type setting (0.01mH~ 65535mH)	STOP
F02.15 (0x020F)	Per unit value of stator resistance	V/F SVC FVC PMVF PMSVC PMFVC Set the per unit value of stator resistance.	Machine type setting (0.01~50.00%)	READ
F02.16 (0x0210)	Per unit value of rotor resistance	V/F SVC FVC PMVF PMSVC PMFVC Set the per unit value of rotor resistance.	Machine type setting	READ
F02.17 (0x0211)	Per unit value of stator leakage inductance	V/F SVC FVC PMVF PMSVC PMFVC Set the per unit value of stator leakage inductance.	Machine type setting (0.01~50.00%)	READ
F02.18 (0x0212)	Per unit value of stator inductance	V/F SVC FVC PMVF PMSVC PMFVC Set the per unit value of stator inductance.	Machine type setting (0.1~999.0%)	READ

F02.2x Group : Advanced parameters of synchronous motor

Parameter code (Address)	Name	Description	Factory value (Setting range)	Adjustable attribute
F02.20 (0x0214)	Synchronous motor stator resistance	V/F SVC FVC PMVF PMSVC PMFVC Set the stator resistance of the synchronizer.	Machine type setting (0.01mΩ~ 60000mΩ)	STOP
F02.21 (0x0215)	Synchronous motor D-axis inductance	V/F SVC FVC PMVF PMSVC PMFVC Set d-axis inductance of synchronizer.	Machine type setting (0.001mH~ 6553.5mH)	STOP
F02.22 (0x0216)	Synchronous motor Q-axis inductance	V/F SVC FVC PMVF PMSVC PMFVC Set the q-axis inductance of the synchronizer.	Machine type setting (0.001mH~ 6553.5mH)	STOP

F02.23 (0x0217)	Synchronous motor back electromotive force	V/F SVC FVC PMVF PMSVC PMFVC Set the reverse electromotive force of the synchronous motor. Only rotation self-tuning will be recognized.	Machine type setting (0~1500V)	STOP
F02.24 (0x0218)	Synchronous motor encoder installation angle	V/F SVC FVC PMVF PMSVC PMFVC Set the installation angle of synchronous motor encoder.	Machine type setting (0.0°~360.0°)	RUN
F02.25 (0x0219)	Synchronous motor per unit value of stator resistance	V/F SVC FVC PMVF PMSVC PMFVC Set the per unit value of synchronous motor stator resistance.	Machine type setting (Monitoring value)	READ
F02.26 (0x021A)	Synchronous motor per unit value of d-axis inductance	V/F SVC FVC PMVF PMSVC PMFVC Set the unit value of synchronous motor d-axis inductance.	Machine type setting (Monitoring value)	READ
F02.27 (0x021B)	Synchronous motor per unit value of q-axis inductance	V/F SVC FVC PMVF PMSVC PMFVC Set the unit value of synchronous motor q-axis inductance.	Machine type setting (Monitoring value)	READ
F02.28 (0x021C)	Pulse width coefficient of synchronous motor	V/F SVC FVC PMVF PMSVC PMFVC Set the pulse width coefficient of synchronous motor.	Machine type setting (00.00~99.99)	STOP

F02.3x-F02.4x Group : Encoders config

Parameter code	Name	Description	Factory value (Setting)	Adjustable attribute
F02.30 (0x021E)	Speed feedback encoder type	V/F SVC FVC PMVF PMSVC PMFVC 0: Normal ABZ encoder 1: Resolver 2: Sine cosine encoder	0 (0~2)	STOP

SD500spindle servo driver

F02.31 (0x021F)	Encoder direction	V/F SVC FVC PMVF PMSVC PMFVC 0: same direction 1: opposite direction	0 (0~1)	STOP
F02.32 (0x0220)	ABZ encoder selection of Z pulse detection	V/F SVC FVC PMVF PMSVC PMFVC 0: off 1: on (positive pulse) 2: on (negative pulse)	1 (0~1)	STOP
F02.33 (0x0221)	ABZ encoder lines	V/F SVC FVC PMVF PMSVC PMFVC Set the number of ABZ encoder lines.	2500 (1~ 10000)	STOP
F02.35 (0x0223)	Encoder transmission ratio numerator	V/F SVC FVC PMVF PMSVC PMFVC Set encoder transmission ratio numerator	1 (1~ 32767)	RUN
F02.36 (0x0224)	Encoder drive ratio denominator	V/F SVC FVC PMVF PMSVC PMFVC Set encoder drive ratio denominator	1 (1~ 32767)	RUN
F02.37 (0x0225)	Encoder speed measurement filter time	V/F SVC FVC PMVF PMSVC PMFVC Set encoder speed measurement filter time	0.0ms (0.0~ 100.0ms)	RUN
F02.38 (0x0226)	Encoder disconnection detection time	V/F SVC FVC PMVF PMSVC PMFVC Set encoder disconnection detection time	0.500s (0.100~ 60.000s)	RUN
F02.39 (0x0227)	Encoder output division ratio	V/F SVC FVC PMVF PMSVC PMFVC Set encoder output division ratio	1 (1~ 32767)	RUN
F02.40 (0x0228)	Encoder installation position	V/F SVC FVC PMVF PMSVC PMFVC 0: motor single encoder 1: spindle single encoder 2: Double encoder	0 (0~1)	STOP
F02.41 (0x0229)	Positioning encoder direction selection	V/F SVC FVC PMVF PMSVC PMFVC 0: same direction 1: opposite direction	0 (0~1)	STOP
F02.42 (0x022A)	Encoder Z-pulse detection selection	V/F SVC FVC PMVF PMSVC PMFVC 0: off 1: on (positive pulse) 2: on (negative pulse)	1 (0~2)	STOP
F02.43	Positioning	V/F SVC FVC PMVF PMSVC PMFVC	1024	STOP

SD500spindle servo driver

(0x022B)	encoder lines	Set the number of ABZ encoder lines.	(1~ 10000)	
F02.44 (0x022C)	Positioning encoder speed measurement filter time	V/F SVC FVC PMVF PMSVC PMFVC Set positioning encoder speed measurement filter time	1.0ms (0.0~ 100.0ms)	RUN
F02.45 (0x022D)	Frequency division output configuration	V/F SVC FVC PMVF PMSVC PMFVC LED unit digit: frequency division output encoder rotation 0: motor encoder 1: spindle encoder LED Ten digit: frequency division output direction 0: forward 1: reverse	0x0010 (0x0000~ 0x1111)	STOP
F02.46 (0x022E)	Z-pulse break detection turns	V/F SVC FVC PMVF PMSVC PMFVC Set Z-pulse break detection turns	4 (1~ 32767)	RUN

F02.5x Group : Motor application parameters

Parameter code (Address)	Name	Description	Factory value (Setting range)	Adjustable attribute
F02.50 (0x0232)	Stator resistance start learning function selection	V/F SVC FVC PMVF PMSVC PMFVC 0: invalid 1: Learn only and not update Bigger than 1: learn and update	0 (0~3)	STOP
F02.51 (0x0233)	Stator resistance start learning coefficient 1	V/F SVC FVC PMVF PMSVC PMFVC Stator resistance start learning coefficient 1	0 (0~1000)	RUN
F02.52 (0x0234)	Stator resistance start learning coefficient 2	V/F SVC FVC PMVF PMSVC PMFVC Stator resistance start learning coefficient 2	0 (0~1000)	RUN
F02.53 (0x0235)	Stator resistance start learning coefficient 3	V/F SVC FVC PMVF PMSVC PMFVC Stator resistance start learning coefficient 3	0 (0~1000)	RUN
F02.60 (0x023C)	Synchronous motor poles searching function	V/F SVC FVC PMVF PMSVC PMFV LED unit digit: closed loop vector 0: close 1: open 2: On, only the first start after power on LED Ten digit: open loop vector 0: close 1: open 2: On, only the first start after power on	0x0010 (0x0000~ 0x0022)	STOP

4.6 F03 Group : Vector control

F03.0x Group : ASR

Parameter code (Address)	Name	Description	Factory value (Setting range)	Adjustable attribute
F03.00 (0x0300)	ASR Speed rigidity level	V/F SVC FVC PMVF PMSVC PMFVC The higher the level is, the better the speed rigidity is.	32 (0~64)	RUN
F03.01 (0x0301)	ASR Speed rigidity mode	V/F SVC FVC PMVF PMSVC PMFVC ASR Speed rigidity mode.	0x0000 (0x0000~0xffff)	RUN
F03.02 (0x0302)	ASR Proportional gain 1	V/F SVC FVC PMVF PMSVC PMFVC Set ASR proportional gain 1.	20.00 (0.01~100.00)	RUN
F03.03 (0x0303)	ASR Integral time 1	V/F SVC FVC PMVF PMSVC PMFVC Set ASR integral time 1.	0.100s (0.000~ 6.000s)	RUN
F03.04 (0x0304)	ASR Filtering time1	V/F SVC FVC PMVF PMSVC PMFVC Set ASR filtering time 1.	0.0ms (0.0~ 100.0ms)	RUN
F03.05 (0x0305)	ASR switch frequency 1	V/F SVC FVC PMVF PMSVC PMFVC Set ASR switching frequency 1.	10.00Hz (0.00~ Maximum frequency)	RUN
F03.06 (0x0306)	ASR Proportional gain 2	V/F SVC FVC PMVF PMSVC PMFVC Set ASR proportional gain 2.	10.00 (0.01~100.00)	RUN
F03.07 (0x0307)	ASR Integral time 2	V/F SVC FVC PMVF PMSVC PMFVC Set ASR integral time 2.	0.050s (0.000~	RUN
F03.08 (0x0308)	ASR Filtering time2	V/F SVC FVC PMVF PMSVC PMFVC Set ASR filtering time 2.	0.0ms (0.0~ 100.0ms)	RUN
F03.09 (0x0309)	ASR switch frequency 2	V/F SVC FVC PMVF PMSVC PMFVC Set ASR switching frequency 2.	5.00Hz (0.00~	RUN

			Maximum frequency)	
--	--	--	--------------------	--

F03.1x Group : Current loop and torque limit

Parameter code	Name	Description	Factory value (Setting	Adjustable attribute
F03.10 (0x030A)	Current loop d-axis proportional gain	V/F SVC FVC PMVF PMSVC PMFVC Set current loop d-axis proportional gain	1.00 (0.001~ 4.000)	RUN
F03.11 (0x030B)	Current loop d-axis integral gain	V/F SVC FVC PMVF PMSVC PMFVC Set current loop d-axis integral gain	1.00 (0.001~	RUN
F03.12 (0x030C)	Current loop q-axis proportional gain	V/F SVC FVC PMVF PMSVC PMFVC Set current loop q-axis proportional gain	1.00 (0.001~ 4.000)	RUN
F03.13 (0x030D)	Current loop q-axis integral gain	V/F SVC FVC PMVF PMSVC PMFVC Set current loop q-axis integral gain	1.00 (0.001~ 4.000)	RUN
F03.15 (0x030E)	Electric torque limit	V/F SVC FVC PMVF PMSVC PMFVC Set electric torque limit	250.0% (0.0~ 400.0%)	RUN
F03.16 (0x030F)	Power generation torque limit	V/F SVC FVC PMVF PMSVC PMFVC Set power generation torque limit	350.0% (0.0~ 400.0%)	RUN
F03.17 (0x0312)	Low speed regeneration torque limit	V/F SVC FVC PMVF PMSVC PMFVC Set low speed regeneration torque limit	0.0% (0.0~ 400.0%)	RUN
F03.18 (0x0313)	Low speed torque limit action frequency amplitude	V/F SVC FVC PMVF PMSVC PMFVC Set low speed torque limit action frequency amplitude	6.00s (0.00~ 30.00s)	RUN

F03.2x Group : Torque optimization control

Parameter code (Address)	Name	Description	Factory value (Setting range)	Adjustable attribute
F03.20 (0x0314)	Synchronous motor low frequency pull in current	V/F SVC FVC PMVF PMSVC PMFVC The open-loop control of PM motor is effective, and the larger the pull in current is, the larger the torque output is.	20.0% (0.0~50.0%)	RUN
F03.21 (0x0315)	Synchronous motor high frequency pull in current	V/F SVC FVC PMVF PMSVC PMFVC The open-loop control of PM motor is effective, and the larger the pull in current is, the larger the torque output is.	10.0% (0.0~50.0%)	RUN
F03.22 (0x0316)	Synchronous motor pull in current frequency	V/F SVC FVC PMVF PMSVC PMFVC The set value of 100.0% corresponds to F01.10 [maximum frequency].	10.0% (0.0~100.0%)	RUN
F03.23 (0x0317)	Asynchronous motor slip compensation	V/F SVC FVC PMVF PMSVC PMFVC Set asynchronous motor slip compensation	100.0% (0.0~250.0%)	RUN
F03.24 (0x0318)	Starting torque initial value	V/F SVC FVC PMVF PMSVC PMFVC Set starting torque initial value	0.0% (0.0~	RUN

F03.3x Group : Flux optimization

Parameter code	Name	Description	Factory value (Setting range)	Adjustable attribute
F03.30 (0x031E)	Weak magnetic feedforward coefficient	V/F SVC FVC PMVF PMSVC PMFVC Set weak magnetic feedforward coefficient	10.0% (0.0~200.0%)	RUN
F03.31 (0x031F)	Weak magnetic control gain	V/F SVC FVC PMVF PMSVC PMFVC Set weak magnetic control gain	100.0% (0.0~	RUN
F03.32 (0x0320)	Weak magnetic current upper limit	V/F SVC FVC PMVF PMSVC PMFVC Set weak magnetic current upper limit	60.0% (0.0~	STOP

			250.0%)	
F03.33 (0x0321)	Weak magnetic voltage coefficient	V/F SVC FVC PMVF PMSVC PMFVC Set weak magnetic voltage coefficient	97.0% (0.0~ 120.0%)	STOP
F03.34 (0x0322)	Output power limit	V/F SVC FVC PMVF PMSVC PMFVC Set output power limit	250.0% (0.0~ 400.0%)	RUN
F03.35 (0x0323)	Over excitation braking gain	V/F SVC FVC PMVF PMSVC PMFVC Set over excitation braking gain	100.0% (0.0~ 500.0%)	RUN
F03.36 (0x0324)	Over excitation brake limiting	V/F SVC FVC PMVF PMSVC PMFVC Set over excitation brake limiting	100.0% (0.0~ 250.0%)	RUN
F03.37 (0x0325)	Energy saving operation	V/F SVC FVC PMVF PMSVC PMFVC 0: off 1: on	0 (0~1)	RUN
F03.38 (0x0326)	Energy saving operation excitation lower limit	V/F SVC FVC PMVF PMSVC PMFVC Set energy saving operation excitation lower limit	50.0% (0.0~80.0%)	RUN
F03.39 (0x0327)	Energy saving operation filter coefficient	V/F SVC FVC PMVF PMSVC PMFVC Set energy saving operation filter coefficient	0.010s (0.000~ 6.000s)	RUN

F03.4x-F03.5x Group : Torque control

Parameter code (Address)	Name	Description	Factory value (Setting range)	Adjustable attribute
F03.40 (0x0328)	Torque control selection	V/F SVC FVC PMVF PMSVC PMFVC 0: Speed control mode torque limit 1: Speed limit of torque control mode	0 (0~1)	RUN

F03.41 (0x0329)	Torque command setting	<p>V/F SVC FVC PMVF PMSVC</p> <p>PMFVC</p> <p>LED unit digit: Channel A</p> <p>LED Ten digit: Channel B</p> <p>0: Keyboard number setting</p> <p>1: Reserved</p> <p>2: Current/Voltage analog AI1 setting</p> <p>3: Current/Voltage analog AI2 setting</p> <p>4: Reserved</p> <p>5: PUL</p> <p>6: RS485 communication setting</p> <p>LED Hundre digit: mode</p> <p>0:A</p> <p>1:B</p> <p>2:A+B</p> <p>3:A-B</p> <p>4:MIN(A,B)</p> <p>5:MAX(A,B)</p>	0x0000 (0x0000~0x0577)	RUN
F03.42 (0x032A)	Torque keyboard number setting	<p>V/F SVC FVC PMVF PMSVC</p> <p>PMFVC</p> <p>Set torque command setting.</p>	0.0% (0.0~100.0%)	RUN
F03.43 (0x032B)	Torque input lower limit	<p>V/F SVC FVC PMVF PMSVC</p> <p>PMFVC</p> <p>Set torque input lower limit</p>	0.00% (0.0~100.00%)	RUN
F03.44 (0x032C)	Lower limit corresponding setting	<p>V/F SVC FVC PMVF PMSVC</p> <p>PMFVC</p> <p>Set the corresponding value of the lower limit.</p>	0.0% (-200.0~200.0%)	RUN
F03.45 (0x032D)	Torque input upper limit	<p>V/F SVC FVC PMVF PMSVC</p> <p>PMFVC</p> <p>Set the torque input upper limit.</p>	100.0% (0.0~100.0%)	RUN

SD500spindle servo driver

F03.46 (0x032E)	Upper limit corresponding setting	V/F SVC FVC PMVF PMSVC PMFVC Set the corresponding value of the upper limit.	100.0% (-200.0~200.0%)	RUN
F03.47 (0x032F)	Torque filtering time	V/F SVC FVC PMVF PMSVC PMFVC Set the torque limit action frequency amplitude at low speed.	0.100s (0.000~6.000s)	RUN
F03.52 (0x0334)	Output torque upper limit	V/F SVC FVC PMVF PMSVC PMFVC Set the output torque upper limit.	150.0% (0.0~200.0%)	RUN
F03.53 (0x0335)	Output torque lower limit	V/F SVC FVC PMVF PMSVC PMFVC Set the output torque lower limit.	0.0% (0.0~200.0%)	RUN
F03.54 (0x0336)	Torque control forward speed limit selection	V/F SVC FVC PMVF PMSVC PMFVC 0: Parameter code F03.56 setting; 1: Reserved 2: AI1xF03.56; 3: AI2xF03.56; 4: Reserved 5: PULxF03.56; 6: RS485 communication settingxF03.56 7: Reserved	0 (0~7)	RUN
F03.55 (0x0337)	Torque control reverse speed limit selection	V/F SVC FVC PMVF PMSVC PMFVC 0: Parameter code F03.57 setting; 1: Reserved 2: AI1xF03.57; 3: AI2xF03.57; 4: Reserved 5: PULxF03.57;	0 (0~7)	RUN

		6: RS485 communication setting×F03.57 7: Reserved		
F03.56 (0x0338)	Torque control forward speed limit	V/F SVC FVC PMVF PMSVC PMFVC Set the torque control forward speed limit.	100.0% (0.0~100.0%)	RUN
F03.57 (0x0339)	Torque control reverse maximum speed limit	V/F SVC FVC PMVF PMSVC PMFVC Set torque control reverse maximum speed limit.	100.0% (0.0~100.0%)	RUN

F03.6x Group : PM high frequency injection

Parameter code (Address)	Name	Description	Factory value (Setting range)	Adjustable attribute
F03.60 (0x033C)	High frequency injection selection	V/F SVC FVC PMVF PMSVC PMFVC Open loop control of PM motor is effective 0: forbid 1~5: enable, the higher the value, the higher the injection frequency	0 (0~5)	STOP
F03.61 (0x033D)	High frequency injection voltage	V/F SVC FVC PMVF PMSVC PMFVC Injection voltage amplitude, relative rated voltage, self-learning results, generally do not need to be modified.	10.0% (0.0~100.0%)	RUN
F03.62 (0x033E)	High frequency injection cut-off frequency	V/F SVC FVC PMVF PMSVC PMFVC The high frequency injection is effective when the motor speed is less than the rated frequency.	10.0% (0.0~100.0%)	RUN

F03.7x Group : Position compensation

Parameter code (Address)	Name	Description	Factory value (Setting range)	Adjustable attribute
F03.70 (0x0346)	Position compensation control	V/F SVC FVC PMVF PMSVC PMFVC Position compensation control under speed control can realize zero servo or improve system rigidity	0 (0~5)	RUN

F03.71 (0x0347)	Compensation gain	V/F SVC FVC PMVF PMSVC PMFVC Set compensation gain	1.0% (0.0~250.0%)	RUN
F03.72 (0x0348)	Compensation limit amplitude	V/F SVC FVC PMVF PMSVC PMFVC Set compensation limit amplitude.	0.0% (0.0~100.0%)	STOP
F03.73 (0x0349)	Compensation action range	V/F SVC FVC PMVF PMSVC PMFVC Set the compensation action range.	10.0% (0.0~100.0%)	STOP

F03.8x Group : Extended control

Parameter code (Address)	Name	Description	Factory value (Setting range)	Adjustable attribute
F03.80 (0x0350)	Synchronous motor MTPA gain	V/F SVC FVC PMVF PMSVC PMFVC Set synchronous motor MTPA gain	100.0% (0.0~400.0%)	RUN
F03.81 (0x0351)	Synchronous motor MTPA	V/F SVC FVC PMVF PMSVC PMFV Set synchronous motor MTPA filtering time	1.0ms (0.0~100.0ms)	RUN

4.7 F04 Group : V/F control**F04.0x Group : V/F control**

Parameter code (Address)	Name	Description	Factory value (Setting range)	Adjustable attribute
F04.00 (0x0400)	Linear VF curve selection	V/F SVC FVC PMVF PMSVC PMFVC Used to select the type of V / F curve to meet the requirements of different load characteristics. 0: straight line VF curve; 1-9: 1.1-1.9 respectively power VF curve; 10: Square VF curve; 11: Custom VF curve;	0 (0~11)	STOP
F04.01 (0x0401)	Torque boost	V/F SVC FVC PMVF PMSVC PMFVC 0.0%: Automatic torque boost	0.0% (0.0~30.0%)	RUN

F04.02 (0x0402)	Torque boost cut-off frequency	<p>√/F SVC FVC PMVF PMSVC PMFVC</p> <p>Set the effective range of torque boost function.</p> <p>When the output frequency exceeds this value, the torque boost function will be cut off.</p>	100.0% (0.0~100.0%)	RUN
F04.03 (0x0403)	Slip compensation gain	<p>√/F SVC FVC PMVF PMSVC PMFVC</p> <p>Set slip compensation gain.</p>	0.0% (0.0~200.0%)	RUN
F04.04 (0x0404)	Slip compensation limit	<p>√/F SVC FVC PMVF PMSVC PMFVC</p> <p>Set slip compensation limit.</p>	100.0% (0.0~300.0%)	RUN
F04.05 (0x0405)	Slip compensation filter time	<p>√/F SVC FVC PMVF PMSVC PMFVC</p> <p>The slip compensation function needs to correctly input the motor nameplate parameters and carry out parameter learning to achieve the best effect.</p>	0.200 (0.000~6.000)	RUN
F04.06 (0x0406)	Surge suppression gain	<p>√/F SVC FVC PMVF PMSVC PMFVC</p> <p>By adjusting the value, the low-frequency resonance can be suppressed, but it can not be too large, otherwise it will cause additional stability problems.</p>	100.0% (0.0~900.0%)	RUN
F04.07 (0x0407)	Surge suppression filter time	<p>√/F SVC FVC PMVF PMSVC PMFVC</p> <p>Set surge suppression filter time.</p>	1.0 (0.0~100.0s)	RUN
F04.08 (0x0408)	Output voltage percentage	<p>√/F SVC FVC PMVF PMSVC PMFVC</p> <p>Set output voltage percentage.</p>	100.0% (25.0~120.0%)	STOP

F04.1x Group : Self-setting V/F curve

Parameter code (Address)	Name	Description	Factory value (Setting range)	Adjustable attribute
F04.10 (0x040A)	Self-setting voltage V1	<p>√/F SVC FVC PMVF PMSVC PMFVC</p> <p>Set self-setting voltage V1</p>	3.0% (0.0~100.0%)	STOP

F04.11 (0x040B)	Self-setting frequency F1	V/F SVC FVC PMVF PMSVC PMFVC Self-setting frequency F1	1.00Hz (0.00~Max)	STOP
F04.12 (0x040C)	Self-setting voltage V2	V/F SVC FVC PMVF PMSVC PMFVC Self-setting voltage V2	28.0% (0.0~100.0%)	STOP
F04.13 (0x040D)	Self-setting frequency F2	V/F SVC FVC PMVF PMSVC PMFVC Self-setting frequency F2	10.0Hz (0.00~Max frequency)	STOP
F04.14 (0x040E)	Self-setting voltage V3	V/F SVC FVC PMVF PMSVC PMFVC Self-setting voltage V3	55.0% (0.0~100.0%)	STOP
F04.15 (0x040F)	Self-setting frequency F3	V/F SVC FVC PMVF PMSVC PMFVC Self-setting frequency F3	25.00Hz (0.00~Max frequency)	STOP
F04.16 (0x0410)	Self-setting voltage V4	V/F SVC FVC PMVF PMSVC PMFVC Self-setting voltage V4	78.0% (0.0~900.0%)	STOP
F04.17 (0x0411)	Self-setting frequency F4	V/F SVC FVC PMVF PMSVC PMFVC Self-setting frequency F4	37.5Hz (0.00~Max frequency)	STOP
F04.18 (0x0412)	Self-setting voltage V5	V/F SVC FVC PMVF PMSVC PMFVC Self-setting voltage V5	100.0% (0.0~100.0%)	STOP
F04.19 (0x0413)	Self-setting frequency F5	V/F SVC FVC PMVF PMSVC PMFVC Self-setting frequency F5	50.0Hz (0.00~Max frequency)	STOP

F04.2x Group : Reserved**F04.3x Group: V/F energy saving control**

Parameter code (Address)	Name	Description	Factory value (Setting range)	Adjustable attribute
F04.30 (0x041E)	Auto energy saving control	V/F SVC FVC PMVF PMSVC PMFVC 0: OFF 1: ON	0 (0~1)	STOP
F04.31 (0x041F)	Energy saving frequency lower	V/F SVC FVC PMVF PMSVC PMFVC Set energy saving frequency lower limit.	15.0Hz (0.0~50.0Hz)	STOP
F04.32 (0x0420)	Energy saving voltage lower limit	V/F SVC FVC PMVF PMSVC PMFVC Set energy saving voltage lower limit.	50.0% (20.0~100.0%)	STOP

F04.33 (0x0421)	Energy saving voltage regulation rate	V/F SVC FVC PMVF PMSVC PMFVC Set energy saving voltage regulation rate.	0.010V/MS (0.000~0.200 V/MS)	RUN
F04.34 (0x0422)	Energy saving voltage recovery rate	V/F SVC FVC PMVF PMSVC PMFVC Set energy saving voltage recovery rate.	0.20V/MS (0.00~2.00 V/MS)	RUN

4.8 F05 Group : Input terminal

F05.0x group : Digital input terminal function

Parameter code (Address)	Name	Description	Factory value (Setting range)	Adjustable attribute
F05.00 (0x0500)	Terminal X1 function selection	V/F SVC FVC PMVF PMSVC PMFVC See function of terminal x for details	1 (0~85)	STOP
F05.01 (0x0501)	Terminal X2 function selection	V/F SVC FVC PMVF PMSVC PMFVC See function of terminal x for details	2 (0~85)	STOP
F05.02 (0x0502)	Terminal X3 function selection	V/F SVC FVC PMVF PMSVC PMFVC See function of terminal x for details	80 (0~85)	STOP
F05.03 (0x0503)	Terminal X4 function selection	V/F SVC FVC PMVF PMSVC PMFVC See function of terminal x for details	61 (0~85)	STOP
F05.04 (0x0504)	Terminal X5 function selection	V/F SVC FVC PMVF PMSVC PMFVC See function of terminal x for details	64 (0~85)	STOP
F05.05 (0x0505)	Terminal X6 function selection	V/F SVC FVC PMVF PMSVC PMFVC See function of terminal x for details	8 (0~85)	STOP
F05.06 (0x0506)	Terminal X7 function selection	V/F SVC FVC PMVF PMSVC PMFVC See function of terminal x for details	7 (0~85)	STOP

F05.1x group : curve X1-X5 detection delay

Parameter code (Address)	Name	Description	Factory value (Setting range)	Adjustable attribute
F05.10 (0x050A)	X1 valid detection delay	V/F SVC FVC PMVF PMSVC PMFVC Delay of terminal X1 from invalid to valid.	0.010 (0.000~6.000s)	RUN
F05.11 (0x050B)	X1 invalid detection delay	V/F SVC FVC PMVF PMSVC PMFVC Delay of terminal X1 from valid to invalid.	0.010 (0.000~6.000s)	RUN
F05.12 (0x050C)	X2 valid detection delay	V/F SVC FVC PMVF PMSVC PMFVC Delay of terminal X2 from invalid to valid.	0.010 (0.000~6.000s)	RUN
F05.13 (0x050D)	X2 invalid detection delay	V/F SVC FVC PMVF PMSVC PMFVC Delay of terminal X2 from valid to invalid.	0.010 (0.000~6.000s)	RUN
F05.14 (0x050E)	X3 valid detection delay	V/F SVC FVC PMVF PMSVC PMFVC Delay of terminal X3 from invalid to valid.	0.010 (0.000~6.000s)	RUN
F05.15 (0x050F)	X3 invalid detection delay	V/F SVC FVC PMVF PMSVC PMFVC Delay of terminal X3 from valid to invalid.	0.010 (0.000~6.000s)	RUN
F05.16 (0x0510)	X4 valid detection delay	V/F SVC FVC PMVF PMSVC PMFVC Delay of terminal X4 from invalid to valid.	0.010 (0.000~6.000s)	RUN
F05.17 (0x0511)	X4 invalid detection delay	V/F SVC FVC PMVF PMSVC PMFVC Delay of terminal X4 from valid to invalid.	0.010 (0.000~6.000s)	RUN
F05.18 (0x0512)	X5 valid detection delay	V/F SVC FVC PMVF PMSVC PMFVC Delay of terminal X5 from invalid to valid.	0.010 (0.000~6.000s)	RUN
F05.19 (0x0513)	X5 invalid detection delay	V/F SVC FVC PMVF PMSVC PMFVC Delay of terminal X5 from valid to invalid.	0.010 (0.000~6.000s)	RUN

F05.2x Group : Action selection of digital input terminal

Parameter code (Address)	Name	Description	Factory value (Setting range)	Adjustable attribute
F05.20 (0x0514)	Terminal control operation mode	V/F SVC FVC PMVF PMSVC PMFVC 0: two wire system 1: two wire system 2	0 (0~3)	STOP

		2: Three wire system 1 3: three wire system 2 Note: see Appendix II for terminal connection mode.		
F05.22 (0x0516)	X1~X4 Terminal property selection	V/F SVC FVC PMVF PMSVC PMFVC 0: valid for closing 1: valid for opening LED "0" digit: X1 terminal LED Ten digit: x2 terminal LED Hundre digit: X3 terminal LED Thousand digit: X4 terminal	0000 (0000~1111)	RUN
F05.23 (0x0517)	X5~X7 Terminal property selection	V/F SVC FVC PMVF PMSVC PMFVC 0: valid for closing 1: valid for opening LED "0" digit: X5 terminal LED Ten digit: x6 terminal LED Hundre digit: X7 terminal	0000 (0000~0111)	RUN
F05.25 (0x0519)	Terminal UP/DW control selection	V/F SVC FVC PMVF PMSVC PMFVC 0: frequency power down storage 1: Frequency power failure does not store 2: Adjustable in operation, stop and clear	0 (0~2)	STOP
F05.26 (0x051A)	Terminal UP/DW control frequency ACC & DEC speed rate	V/F SVC FVC PMVF PMSVC PMFVC Set terminal UP/DW control frequency ACC & DEC speed rate	0.50Hz/s (0.01~ 50.00Hz/s)	RUN
F05.27 (0x051B)	Terminal emergency stop deceleration time	V/F SVC FVC PMVF PMSVC PMFVC Set terminal emergency stop deceleration time.	1.00s (0.01~650.00s)	RUN

F05.3x group : PUL terminal

Parameter code (Address)	Name	Description	Factory value (Setting)	Adjustable attribute
F05.31 (0x051F)	PUL input min frequency	V/F SVC FVC PMVF PMSVC PMFVC The minimum frequency accepted by PUL, if the frequency signal below this value, the spindle drive will be processed at the minimum frequency. 0.00~50.000kHz	0.00kHz (0.00~ 500.00kHz)	RUN
F05.32 (0x0520)	PUL min frequency corresponding setting	V/F SVC FVC PMVF PMSVC PMFVC Percentage corresponding to the set value	0.00% (0.00~ 100.00%)	RUN
F05.33 (0x0521)	PUL input max frequency	V/F SVC FVC PMVF PMSVC PMFVC The maximum frequency accepted by PUL, if the frequency signal higher than this value, the spindle drive will be processed at the maximum frequency. 0.00~50.000kHz	50.00kHz (0.00~ 500.00kHz)	RUN
F05.34 (0x0522)	PUL max frequency corresponding setting	V/F SVC FVC PMVF PMSVC PMFVC Percentage corresponding to the set value	100.00% (0.00~ 100.00%)	RUN
F05.35 (0x0523)	PUL filtering time	V/F SVC FVC PMVF PMSVC PMFVC The size of filtering the input pulse signal to eliminate interference signals.	0.100s (0.000~ 9.000s)	RUN
F05.36 (0x0524)	PUL cut-off frequency	V/F SVC FVC PMVF PMSVC PMFVC If the frequency below this parameter, the spindle drive is no longer recognized. Process the frequency as 0Hz.	0.010kHz (0.000~ 1.000kHz)	RUN

F05.4x Group : Analog (AI) type processing

Parameter code (Address)	Name	Description	Factory value (Setting range)	Adjustable attribute
F05.42 (0x052A)	AI2 Input signal type	V/F SVC FVC PMVF PMSVC PMFVC 0: Voltage 0~10.00V 1: Current 0~20.00mA	0 (0~1)	RUN
F05.43 (0x052B)	Analog input curve selection	V/F SVC FVC PMVF PMSVC PMFVC 0: Line (default) 1: Curve 1 2: Curve 2 LED "0" digit: AI1 LED "00" digit: AI2 LED "000" digit: Reserved LED "0000" digit: Reserved	0x0000 (0x0000~ 0x0022)	RUN

F05.5x Group : Analog (AI) linear processing

Parameter code (Address)	Name	Description	Factory value (Setting range)	Adjustable attribute
F05.50 (0x0532)	AI1 lower limit	V/F SVC FVC PMVF PMSVC PMFVC Define the signal received by AI1 terminal, and the voltage signal lower than this value shall be processed according to the lower limit value.	-100.0% (-100.0~ 100.0%)	RUN
F05.51 (0x0533)	AI1 lower limit corresponding setting	V/F SVC FVC PMVF PMSVC PMFVC Set the percentage of the corresponding set value.	-100.0% (-100.0~ 100.0%)	RUN
F05.52 (0x0534)	AI1 upper limit	V/F SVC FVC PMVF PMSVC PMFVC Define the signal received by the AI1 terminal, and the voltage signal higher than this value shall be processed according to the upper limit value.	100.0% (-100.0~ 100.0%)	RUN

F05.53 (0x0535)	AI1 upper limit corresponding setting	<u>V/F</u> <u>SVC</u> <u>FVC</u> <u>PMVF</u> <u>PMSVC</u> <u>PMFVC</u> Set the percentage of the corresponding set value.	100.00% (0.00~ 100.00%)	RUN
F05.54 (0x0536)	AI1 filtering time	<u>V/F</u> <u>SVC</u> <u>FVC</u> <u>PMVF</u> <u>PMSVC</u> <u>PMFVC</u> Define the size of filtering the analog signal to eliminate interference signals.	0.010s (0.000~6.000s)	RUN
F05.55 (0x0537)	AI2 lower limit	<u>V/F</u> <u>SVC</u> <u>FVC</u> <u>PMVF</u> <u>PMSVC</u> <u>PMFVC</u> Define the signal received by AI2 terminal, and the voltage signal lower than this value shall be processed according to the lower limit value.	0.0% (0.0~100.0%)	RUN
F05.56 (0x0538)	AI2 lower limit corresponding setting	<u>V/F</u> <u>SVC</u> <u>FVC</u> <u>PMVF</u> <u>PMSVC</u> <u>PMFVC</u> Set the percentage of the corresponding set value.	0.00% (-100.00~ 100.00%)	RUN
F05.57 (0x0539)	AI2 upper limit	<u>V/F</u> <u>SVC</u> <u>FVC</u> <u>PMVF</u> <u>PMSVC</u> <u>PMFVC</u> Define the signal received by the AI2 terminal, and the voltage signal higher than this value shall be processed according to the upper limit value.	100.0% (0.0~100.0%)	RUN
F05.58 (0x053A)	AI2 upper limit corresponding setting	<u>V/F</u> <u>SVC</u> <u>FVC</u> <u>PMVF</u> <u>PMSVC</u> <u>PMFVC</u> Set the percentage of the corresponding set value.	100.00% (-100.00~ 100.00%)	RUN
F05.59 (0x053B)	AI2 filtering time	<u>V/F</u> <u>SVC</u> <u>FVC</u> <u>PMVF</u> <u>PMSVC</u> <u>PMFVC</u> Define the size of filtering the analog signal to eliminate interference signals.	0.010s (0.000~6.000s)	RUN

F05.6x Group : AI Curve 1 processing

Parameter code (Address)	Name	Description	Factory value (Setting range)	Adjustable attribute
F05.60 (0x053C)	Curve 1 lower limit value	<u>V/F</u> <u>SVC</u> <u>FVC</u> <u>PMVF</u> <u>PMSVC</u> <u>PMFVC</u> Set curve 1 lower limit value.	0.0% (0.0~100.0%)	RUN

F05.61 (0x053D)	Curve 1 lower limit corresponding setting	V/F SVC FVC PMVF PMSVC PMFVC Corresponding set percentage.	0.0% (0.0~100.0%)	RUN
F05.62 (0x053E)	Curve 1 inflexion 1 input voltage	V/F SVC FVC PMVF PMSVC PMFVC Set curve 1 inflexion 1 input voltage.	30.0% (0.0~100.0%)	RUN
F05.63 (0x053F)	Curve 1 inflexion 1 corresponding setting	V/F SVC FVC PMVF PMSVC PMFVC Corresponding set percentage.	30.00% (0.0~100.0%)	RUN
F05.64 (0x0540)	Curve 1 inflexion 2 input voltage	V/F SVC FVC PMVF PMSVC PMFVC Set curve 1 inflexion 2 input voltage.	60.0% (0.0~100.0%)	RUN
F05.65 (0x0541)	Curve 1 inflexion 2 corresponding setting	V/F SVC FVC PMVF PMSVC PMFVC Corresponding set percentage.	70.00% (0.0~100.0%)	RUN
F05.66 (0x0542)	Curve 1 upper limit value	V/F SVC FVC PMVF PMSVC PMFVC Set curve 1 upper limit value.	100.00% (0.0~100.0%)	RUN
F05.67 (0x0543)	Curve 1 upper limit corresponding setting	V/F SVC FVC PMVF PMSVC PMFVC Corresponding set percentage.	100.0% (0.0~100.0%)	RUN

F05.7x Group : AI Curve 2 processing

Parameter code (Address)	Name	Description	Factory value (Setting range)	Adjustable attribute
F05.70 (0x0546)	Curve 2 lower limit value	V/F SVC FVC PMVF PMSVC PMFVC Set curve 2 lower limit value.	0.0% (0.0~100.0%)	RUN

F05.71 (0x0547)	Curve 2 lower limit corresponding setting	V/F SVC FVC PMVF PMSVC PMFVC Corresponding set percentage.	0.0% (0.0~100.0%)	RUN
F05.72 (0x0548)	Curve 2 inflexion 1 input voltage	V/F SVC FVC PMVF PMSVC PMFVC Set curve 2 inflexion 1 input voltage.	30.0% (0.0~100.0%)	RUN
F05.73 (0x0549)	Curve 2 inflexion 1 corresponding setting	V/F SVC FVC PMVF PMSVC PMFVC Corresponding set percentage.	30.00% (0.00~ 100.00%)	RUN
F05.74 (0x054A)	Curve 2 inflexion 2 input voltage	V/F SVC FVC PMVF PMSVC PMFVC Set curve 2 inflexion 2 input voltage.	60.0% (0.0~100.0%)	RUN
F05.75 (0x054B)	Curve 2 inflexion 2 corresponding setting	V/F SVC FVC PMVF PMSVC PMFVC Corresponding set percentage.	70.00% (0.0~100.0%)	RUN
F05.76 (0x054C)	Curve 2 upper limit value	V/F SVC FVC PMVF PMSVC PMFVC Set curve 2 upper limit value.	100.00% (0.0~100.0%)	RUN
F05.77 (0x054D)	Curve 2 upper limit corresponding setting	V/F SVC FVC PMVF PMSVC PMFVC Corresponding set percentage.	100.0% (0.0~100.0%)	RUN

F05.8x Group : AI as digital input terminal

Parameter code (Address)	Name	Description	Factory value (Setting range)	Adjustable attribute
F05.80 (0x0550)	AI used as digital input terminal selection	V/F SVC FVC PMVF PMSVC PMFVC 0: effective at low level 1: effective at high level LED unit digit: AI1 LED Ten digit: AI2	0000 (0000~1111)	RUN
F05.81 (0x0551)	AI terminal function selection (as X terminal)	V/F SVC FVC PMVF PMSVC PMFVC See terminal x function	0 (0~63)	STOP
F05.82 (0x0552)	AI high level setting	V/F SVC FVC PMVF PMSVC PMFVC If the input setting is greater than the high level	70.00% (0.0~100.0%)	RUN

		setting, it is the input high level.		
F05.83 (0x0553)	AI low level setting	V/F SVC FVC PMVF PMSVC PMFVC Less than the low level setting is the low level.	30.00% (0.0~100.0%)	RUN

4.9 F06 Group : output terminal

F06.0x Group : AO(Analog) output

Parameter code (Address)	Name	Description	Factory value (Setting range)	Adjustable attribute
F06.00 (0x0600)	AO output mode selection	V/F SVC FVC PMVF PMSVC PMFVC 0: 0~10V 1: 4.00~20.00mA 2: 0.00~20.00mA	0 (0~2)	RUN

F06.01 (0x0601)	AO output selection	<p>V/F SVC FVC PMVF PMSVC PMFVC</p> <p>0: Given frequency 1: Output frequency 2: Output current 3: Input voltage 4: Output voltage 5: Mechanical speed 6: Given torque 7: Output torque 8: PID given 9: PID feedback 10: Output power 11: Bus voltage 12: AI1 input value 13: AI2 input value 14: Reserved 15: PUL input value 16: Module temperature 1 17: Module temperature 2 18: RS485 communication setting 19: Virtual vY1 function</p>	0 (0~19)	RUN
F06.02 (0x0602)	AO output gain	<p>V/F SVC FVC PMVF PMSVC PMFVC</p> <p>Adjust the value of terminal output analog quantity.</p>	100.0% (0.0~200.0%)	RUN
F06.003 (0x0603)	AO output bias	<p>V/F SVC FVC PMVF PMSVC PMFVC</p> <p>Set the A0 output offset to adjust the zero point of the terminal output.</p>	0.0% (-10.0~10.0%)	RUN
F06.04 (0x0604)	AO output filter	<p>V/F SVC FVC PMVF PMSVC PMFVC</p> <p>The size of filtering for analog signals to eliminate interference signals.</p>	0.01s (0.0~6.00s)	RUN

F06.1x Group : Reserved

F06.2x-F06.3x Group : Digital, relay output

SD500spindle servo driver

Parameter code (Address)	Name	Description	Factory value (Setting range)	Adjustable attribute
F06.20 (0x0614)	Output terminal polarity selection	<p>V/F SVC FVC PMVF PMSVC PMFVC</p> <p>0: positive polarity 1: negative polarity</p> <p>LED unit digit: Y terminal</p> <p>LED Ten digit: relay output terminal 1</p>	0000 (0000~1111)	RUN
F06.21 (0x0615)	Output terminal Y1	<p>V/F SVC FVC PMVF PMSVC PMFVC</p> <p>See terminal Y function.</p>	42 (0~43)	RUN
F06.22 (0x0616)	Relay 1 output (TA-TB-TC)	<p>V/F SVC FVC PMVF PMSVC PMFVC</p> <p>See terminal Y function.</p>	41 (0~43)	RUN
F06.23 (0x0617)	Output terminal Y2	<p>V/F SVC FVC PMVF PMSVC PMFVC</p> <p>See terminal Y function.</p>	8 (0~43)	RUN
F06.24 (0x0618)	Relay 2 output (TA-TB-TC)	<p>V/F SVC FVC PMVF PMSVC PMFVC</p> <p>See terminal Y function.</p>	4 (0~43)	RUN
F06.25 (0x0619)	Y1 output ON delay time	<p>V/F SVC FVC PMVF PMSVC PMFVC</p> <p>Set Y1 output ON delay time.</p>	0.010s (0.000~60.000s)	RUN
F06.26 (0x061A)	Relay 1 output ON delay time	<p>V/F SVC FVC PMVF PMSVC PMFVC</p> <p>Set relay 1 output ON delay time.</p>	0.010s (0.000~60.000s)	RUN
F06.27 (0x061B)	Y2 output ON delay time	<p>V/F SVC FVC PMVF PMSVC PMFVC</p> <p>Set Y2 output ON delay time.</p>	0.010s (0.000~60.000s)	RUN
F06.28 (0x061C)	Relay 2 output ON delay time	<p>V/F SVC FVC PMVF PMSVC PMFVC</p> <p>Set relay 2 output ON delay time.</p>	0.010s (0.000~60.000s)	RUN
F06.29 (0x061D)	Y1 output OFF delay time	<p>V/F SVC FVC PMVF PMSVC PMFVC</p> <p>Set Y1 output OFF delay time.</p>	0.010s (0.000~60.000s)	RUN

F06.30 (0x061E)	Relay 1 output OFF delay time	V/F SVC FVC PMVF PMSVC PMFVC Set relay 1 output OFF delay time.	0.010s (0.000~ 60.000s)	RUN
F06.31 (0x061F)	Y2 output OFF delay	V/F SVC FVC PMVF PMSVC PMFVC Set Y2 output OFF delay time.	0.010s (0.000~ 60.000s)	RUN
F06.32 (0x0620)	Relay 2 output OFF delay time	V/F SVC FVC PMVF PMSVC PMFVC Set relay 2 output OFF delay time.	0.010s (0.000~ 60.000s)	RUN

F06.4x Group : Frequency detection

Parameter code (Address)	Name	Description	Factory value (Setting range)	Adjustable attribute
F06.40 (0x0628)	Frequency detection value 1	V/F SVC FVC PMVF PMSVC PMFVC Set frequency detection value 1.	2.00Hz (0.00~Max frequency)	RUN
F06.41 (0x0629)	Frequency detection	V/F SVC FVC PMVF PMSVC PMFVC Set frequency detection amplitude 1.	1.00Hz (0.00~Max frequency)	RUN
F06.42 (0x062A)	Frequency detection value 2	V/F SVC FVC PMVF PMSVC PMFVC Set frequency detection value 2.	2.00Hz (0.00~Max frequency)	RUN
F06.43 (0x062B)	Frequency detection amplitude 2	V/F SVC FVC PMVF PMSVC PMFVC Set frequency detection amplitude 2.	1.00Hz (0.00~Max frequency)	RUN
F06.44 (0x062C)	Given frequency detection range	V/F SVC FVC PMVF PMSVC PMFVC Set given frequency detection range.	2.00Hz (0.00~Max frequency)	RUN

F06.5x Group : Monitor parameter comparator output

Parameter code (Address)	Name	Description	Factory value (Setting range)	Adjustable attribute
F06.50 (0x0632)	Comparator 1 monitor selection	V/F SVC FVC PMVF PMSVC PMFVC LED unit digit & LED Ten digit: YY setting in monitoring parameter code Cxx.yy 00 to 63 LED Hundre digit & LED Thousand digit: set XX in the monitoring parameter code Cxx.yy 00 to 07	0001 (0000~0763)	RUN
F06.51 (0x0633)	Comparator 1 upper limit	V/F SVC FVC PMVF PMSVC PMFVC Set comparator 1 upper limit value.	3000 (0~65535)	RUN
F06.52 (0x0634)	Comparator 1 lower limit	V/F SVC FVC PMVF PMSVC PMFVC Set comparator 1 lower limit value.	0 (0~65535)	RUN
F06.53 (0x0635)	Comparator 1 offset	V/F SVC FVC PMVF PMSVC PMFVC Set Comparator 1 offset value.	0 (0~1000)	RUN
F06.54 (0x0636)	Action selection when sending CP1	V/F SVC FVC PMVF PMSVC PMFVC 0: continue to run (digital terminal output only) 1: Alarm and free stop 2: Warn and continue 3: Forced stop	0 (0~3)	RUN
F06.55 (0x0637)	Comparator 2 monitor selection	V/F SVC FVC PMVF PMSVC PMFVC LED unit digit & LED Ten digit: YY setting in monitoring parameter code Cxx.yy 00 to 63 LED Hundre digit & LED Thousand digit: set XX in the monitoring parameter code Cxx.yy 00 to 07	0002 (0000~0763)	RUN

F06.56 (0x0638)	Comparator 2 upper limit	V/F SVC FVC PMVF PMSVC PMFVC Set comparator 2 upper limit value.	30 (0~65535)	RUN
F06.57 (0x0639)	Comparator 2 lower limit	V/F SVC FVC PMVF PMSVC PMFVC Set comparator 2 lower limit value.	0 (0~65535)	RUN
F06.58 (0x063A)	Comparator 2 offset	V/F SVC FVC PMVF PMSVC PMFVC Set Comparator 2 offset value.	0 (0~1000)	RUN
F06.59 (0x063B)	Action selection when sending CP2	V/F SVC FVC PMVF PMSVC PMFVC 0: continue to run (digital terminal output only) 1: Alarm and free stop 2: Warn and continue 3: Forced stop	0 (0~3)	RUN

F06.6x Group : Virtual I/O terminal

Parameter code (Address)	Name	Description	Factory value (Setting range)	Adjustable attribute
F06.60 (0x063C)	Virtual vX1 terminal function selection	V/F SVC FVC PMVF PMSVC PMFVC See terminal X function.	0 (0~63)	RUN
F06.61 (0x063D)	Virtual vX2 terminal function selection	V/F SVC FVC PMVF PMSVC PMFVC See terminal X function.	0 (0~63)	RUN
F06.62 (0x063E)	Virtual vX3 terminal function selection	V/F SVC FVC PMVF PMSVC PMFVC See terminal X function.	0 (0~63)	RUN
F06.63 (0x063F)	Virtual vX4 terminal function selection	V/F SVC FVC PMVF PMSVC PMFVC See terminal X function.	0 (0~63)	RUN

F06.64 (0x0640)	vX terminal valid status source	<p>V/F SVC FVC PMVF PMSVC PMFVC</p> <p>0: internal connection with virtual vYn 1: Link with physical terminal Xn 2: Whether function code setting is valid</p> <p>LED unit digit: virtual vX1 LED Ten digit: virtual vX2 LED Hundre digit: virtual vX3 LED Thousand digit: virtual vX4</p>	0000 (0000~2222)	RUN
F06.65 (0x0641)	Virtual vX terminal function code setting valid status	<p>V/F SVC FVC PMVF PMSVC PMFVC</p> <p>0: invalid; 1: valid</p> <p>LED unit digit: virtual vX1 LED Ten digit: virtual vX2 LED Hundre digit: virtual vX3 LED Thousand digit: virtual vX4</p>	0000 (0000~1111)	RUN
F06.66 (0x0642)	Virtual vY1 output selection	<p>V/F SVC FVC PMVF PMSVC PMFVC</p> <p>See terminal Y function.</p>	0 (0~31)	RUN
F06.67 (0x0643)	Virtual vY2 output selection	<p>V/F SVC FVC PMVF PMSVC PMFVC</p> <p>See terminal Y function.</p>	0 (0~31)	RUN
F06.68 (0x0644)	Virtual vY3 output selection	<p>V/F SVC FVC PMVF PMSVC PMFVC</p> <p>See terminal Y function.</p>	0 (0~31)	RUN
F06.69 (0x0645)	Virtual vY4 output selection	<p>V/F SVC FVC PMVF PMSVC PMFVC</p> <p>See terminal Y function.</p>	0 (0~31)	RUN
F06.70 (0x0646)	vY1 output ON delay time	<p>V/F SVC FVC PMVF PMSVC PMFVC</p> <p>Set vY1 output ON delay time.</p>	0.010s (0.000~60.000s)	RUN
F06.71 (0x0647)	vY2 output ON delay time	<p>V/F SVC FVC PMVF PMSVC PMFVC</p> <p>Set vY2 output ON delay time.</p>	0.010s (0.000~60.000s)	RUN
F06.72 (0x0648)	vY3 output ON delay time	<p>V/F SVC FVC PMVF PMSVC PMFVC</p> <p>Set vY3 output ON delay time.</p>	0.010s (0.000~	RUN

			60.000s)	
F06.73 (0x0649)	vY4 output ON delay time	V/F SVC FVC PMVF PMSVC PMFVC Set vY4 output ON delay time.	0.010s (0.000~ 60.000s)	RUN
F06.74 (0x064A)	vY1 output OFF delay time	V/F SVC FVC PMVF PMSVC PMFVC Set vY1 output OFF delay time.	0.010s (0.000~ 60.000s)	RUN
F06.75 (0x064B)	vY2 output OFF delay time	V/F SVC FVC PMVF PMSVC PMFVC Set vY2 output OFF delay time.	0.010s (0.000~ 60.000s)	RUN
F06.76 (0x064C)	vY3 output OFF delay time	V/F SVC FVC PMVF PMSVC PMFVC Set vY3 output OFF delay time.	0.010s (0.000~ 60.000s)	RUN
F06.77 (0x064D)	vY4 output OFF delay time	V/F SVC FVC PMVF PMSVC PMFVC Set vY4 output OFF delay time.	0.010s (0.000~ 60.000s)	RUN

4.10 F07 Group : Operational control

F07.0x Group : Start-up control

Parameter code (Address)	Name	Description	Factory value (Setting range)	Adjustable attribute
F07.00 (0x0700)	Start-up operation mode	V/F SVC FVC PMVF PMSVC PMFVC 0: Start by start-up frequency 1: DC braking before starting from the start-up frequency 2: Start after speed tracking and direction judgment	0 (0~2)	STOP

SD500spindle servo driver

<p>F07.01 (0x0701)</p>	<p>Start-up pre-excitation time</p>	<p>V/F SVC FVC PMVF PMSVC PMFV Only asynchronous machine vector control (no PG) supports pre-excitation, others are ignored</p>	<p>0.00s (0.00~60.00s)</p>	<p>STOP</p>
<p>F07.02 (0x0702)</p>	<p>Start-up frequency</p>	<p>V/F SVC FVC PMVF PMSVC PMFVC When the given frequency is less than this value, it will not start and will be in standby state.</p>	<p>0.50Hz (0.00~Digital setting of upper frequency)</p>	<p>STOP</p>
<p>F07.03 (0x0703)</p>	<p>Start-up protection options</p>	<p>V/F SVC FVC PMVF PMSVC PMFVC 0: close 1: open Units digit: Terminal start protection at abnormal exit Tens digit: Jog terminal start protection at abnormal exit Hundreds digit: Terminal start protection when command channel is switched to terminal Thousands digit: reserved Note: When the free stop, emergency stop and forced stop commands are valid, the terminal start protection is enabled by default, and A.RUNx warning is reported when the protection is activated.</p>	<p>0111 (0000~1111)</p>	<p>STOP</p>
<p>F07.05 (0x0705)</p>	<p>Rotation direction selection</p>	<p>V/F SVC FVC PMVF PMSVC PMFVC Units: Reverse the running direction 0: Unchanged direction 1: Reversed direction Tens place: Running direction prohibited 0: Allow forward and reverse commands 1: Only forward commands are allowed 2: Only reverse commands are allowed Hundreds place: Frequency control command direction 0: Frequency control direction is invalid 1: Frequency control direction is valid Thousands: Reserved</p>	<p>0100 (0000~1111)</p>	<p>STOP</p>

F07.06 (0x0706)	Restart action selection after power failure	V/F SVC FVC PMVF PMSVC PMFVC 0: Invalid 1: Valid.	0 (0~1)	STOP
F07.07 (0x0707)	Waiting time for restart after power failure	V/F SVC FVC PMVF PMSVC PMFVC Set the waiting time for restart after power failure	0.50s (0.00~60.00s)	STOP

F07.1x group: stop control

Parameter code (address)	Name	Content	Factory default (Predetermined area)	Adjustable properties
F07.10 (0x070A)	Stop mode	V/F SVC FVC PMVF PMSVC PMFVC 0: Deceleration stop 1: Free stop	0 (0~1)	RUN
F07.11 (0x070B)	Stop detection frequency	V/F SVC FVC PMVF PMSVC PMFVC When decelerating and stopping, when the output frequency of the spindle driver is less than this value, it enters into a stop state	0.50Hz (0.00 ~ digital setting of upper limit frequency)	RUN
F07.12 (0x070C)	Stop and restart limit time	V/F SVC FVC PMVF PMSVC PMFVC Wait time for restart after shutdown	0.00s (0.00~60.00s)	STOP
F07.15 (0x070F)	Lower limit frequency action selection	V/F SVC FVC PMVF PMSVC PMFVC 0: Run according to frequency command 1: Free running stops and enters pause state 2: Lower limit frequency operation 3: Zero speed operation	0 (0~3)	RUN
F07.16 (0x0710)	Zero speed torque holding coefficient	V/F SVC FVC PMVF PMSVC PMFVC Set zero speed torque current, 100.0% corresponds to the rated current of the spindle drive	60.0% (0.0~150.0%)	RUN
F07.17 (0x0711)	Zero speed torque holding time	V/F SVC FVC PMVF PMSVC PMFVC Set zero speed torque holding time	0s (0.0~6000.0s)	RUN

F07.18 (0x0712)	Forward and reverse dead time	V/F SVC FVC PMVF PMSVC PMFVC Forward / reverse switching, zero frequency hold time	0.0s (0.0~120.0s)	STOP
--------------------	-------------------------------	---	----------------------	------

F07.2x group: DC braking and speed tracking

Parameter code (address)	Name	Content	Factory default (Predetermined area)	Adjustable properties
F07.20 (0x0714)	Braking current before starting	V/F SVC FVC PMVF PMSVC PMFVC Set the braking current before starting	60.0% (0.0~150.0%)	STOP
F07.21 (0x0715)	Braking time before starting	V/F SVC FVC PMVF PMSVC PMFVC Set the braking time before starting	0.0s (0.0~60.0s)	STOP
F07.22 (0x0716)	DC braking start frequency	V/F SVC FVC PMVF PMSVC PMFVC Set DC braking start frequency	1.00Hz (0.00~50.00Hz)	STOP
F07.23 (0x0717)	DC braking current	V/F SVC FVC PMVF PMSVC PMFVC The reference is the rated current of the spindle drive, and the internal limit does not exceed the rated current of the motor	60.0% (0.0~150.0%)	STOP
F07.24 (0x0718)	DC braking during stop time	V/F SVC FVC PMVF PMSVC PMFVC Set DC braking time during stop	0.0s (0.0~60.0s)	STOP
F07.25 (0x0719)	Speed tracking mode	V/F SVC FVC PMVF PMSVC PMFVC Unit: search method 0: Search from maximum frequency 1: Search from shutdown frequency Tenth place: reverse search 0: Off 1: On Hundreds: Search Source 0: Software search 1: Hardware search	00 (00~11)	STOP

		Thousands: Reserved		
F07.26 (0x071A)	Speed tracking speed	V/F SVC FVC PMVF PMSVC PMFVC Set speed tracking speed	0.5s (0.0~60.0s)	STOP
F07.27 (0x071B)	Speed tracking shutdown delay	V/F SVC FVC PMVF PMSVC PMFVC Set speed tracking stop delay	1.00s (0.0~60.0s)	STOP
F07.28 (0x071C)	Speed tracking current	V/F SVC FVC PMVF PMSVC PMFVC Set speed tracking current	120.0% (0.0~400.0%)	STOP

F07.3x group: Jog

Parameter code (address)	Name	Content	Factory default (Predetermined area)	Adjustable properties
F07.30 (0x071E)	Jog running frequency setting	V/F SVC FVC PMVF PMSVC PMFVC Set jog running frequency	5.00Hz (0.00 ~ max frequency)	RUN
F07.31 (0x071F)	Jog acceleration time	V/F SVC FVC PMVF PMSVC PMFVC Set jog acceleration time	10.0s (0.0~650.0s)	RUN
F07.32 (0x0720)	Jog deceleration time	V/F SVC FVC PMVF PMSVC PMFVC Set jog deceleration time	10.0s (0.0~650.0s)	RUN
F07.33 (0x0721)	Jog S curve selection	V/F SVC FVC PMVF PMSVC PMFVC Set jog S curve selection 0: Invalid 1: Valid	0 (0~1)	RUN
F07.34 (0x0722)	Jog stop mode selection	V/F SVC FVC PMVF PMSVC PMFVC Set jog stop mode 0: Set mode according to F7.10 1: Only decelerate to stop	0 (0~1)	STOP

F07.4x group: Start, stop frequency maintenance and jump frequency

Parameter code (address)	Name	Content	Factory default (Predetermined area)	Adjustable properties
F07.40 (0x0728)	Maintenance frequency at startup	V/F SVC FVC PMVF PMSVC PMFVC The starting maintenance frequency is greater than the starting frequency and less than the upper limit digital setting frequency	0.50Hz (0.00 ~ digital setting of upper limit frequency)	STOP
F07.41 (0x0729)	Maintenance frequency at startup	V/F SVC FVC PMVF PMSVC PMFVC The setting value must be greater than the starting frequency.	0.0s (0.0~60.0s)	STOP
F07.42 (0x072A)	Maintenance frequency during shutdown	V/F SVC FVC PMVF PMSVC PMFVC Set stop maintenance frequency	0.50Hz (0.00 ~ digital setting of upper limit frequency)	STOP
F07.43 (0x072B)	Maintenance frequency during shutdown time	V/F SVC FVC PMVF PMSVC PMFVC Set the shutdown maintenance frequency time	0.0s (0.0~60.0s)	STOP
F07.44 (0x072C)	Jump frequency 1	V/F SVC FVC PMVF PMSVC PMFVC Set jump frequency 1	0.00Hz (0.00 ~ max frequency)	RUN
F07.45 (0x072D)	Jump frequency 1 amplitude	V/F SVC FVC PMVF PMSVC PMFVC Set jump frequency 1 amplitude	0.00Hz (0.00 ~ max frequency)	RUN
F07.46 (0x072E)	Jump frequency 2	V/F SVC FVC PMVF PMSVC PMFVC Set jump frequency 2	0.00Hz (0.00 ~ max frequency)	RUN
F07.47 (0x072F)	Jump frequency 2 amplitude	V/F SVC FVC PMVF PMSVC PMFVC Set jump frequency 2 amplitude	0.00Hz (0.00 ~ max frequency)	RUN

4.11 F08 group: auxiliary control

F08.0x group: counting and timing

Parameter code (address)	Name	Content	Factory default (Predetermined area)	Adjustable properties
F08.00 (0x0800)	Counter input source	V/F SVC FVC PMVF PMSVC PMFVC 0: Ordinary x terminal 1: Input terminal PUL.2 ~ 5: Reserved	0 (0~5)	RUN
F08.01 (0x0801)	Counting input divide	V/F SVC FVC PMVF PMSVC PMFVC Set the count input divide	0 (0~6000)	RUN
F08.02 (0x0802)	Counter maximum	V/F SVC FVC PMVF PMSVC PMFVC Set the counter maximum value	1000 (0~65000)	RUN
F08.03 (0x0803)	Counter set value	V/F SVC FVC PMVF PMSVC PMFVC Set counter set value	500 (0~65000)	RUN
F08.04 (0x0804)	Pulses per meter	V/F SVC FVC PMVF PMSVC PMFVC Count value per meter	10.0 (0.1~6500.0)	RUN
F08.05 (0x0805)	Set length	V/F SVC FVC PMVF PMSVC PMFVC Set length	1000 (0~65000M)	STOP
F08.06 (0x0806)	Actual length	V/F SVC FVC PMVF PMSVC PMFVC Set actual length	0 (0~65000M)	STOP
F08.07 (0x0807)	Timer time unit	V/F SVC FVC PMVF PMSVC PMFVC Set timer time unit	0 (0~2)	STOP
F08.08 (0x0808)	Timer set value	V/F SVC FVC PMVF PMSVC PMFVC Set timer set value	0 (0~65000)	STOP

F08.1x Group: Reserved

F08.2x Group: Reserved

F08.3x group: swing frequency control

Parameter code (address)	Name	Content	Factory default (Predetermined area)	Adjustable properties
--------------------------	------	---------	--------------------------------------	-----------------------

F08.30 (0x081E)	Swing frequency control	V/F SVC FVC PMVF PMSVC PMFVC 0: Swing frequency control is invalid 1: Swing frequency control is valid	0 (0~1)	STOP
F08.31 (0x081F)	Swing frequency amplitude control	V/F SVC FVC PMVF PMSVC PMFVC Singles place: start mode 0: automatic 1: terminal manual Tenth place: Pendulum amplitude control 0: Relative center frequency 1: Relative maximum frequency. Hundreds place: preset frequency enable 0: Disable 1: Enable Thousands: Reserved	0000 (0000~0111)	STOP
F08.32 (0x0820)	Swing frequency preset frequency	V/F SVC FVC PMVF PMSVC PMFVC Set wobble frequency preset frequency	0.00Hz (0-upper limit frequency)	STOP
F08.33 (0x0821)	Swing frequency preset frequency waiting time	V/F SVC FVC PMVF PMSVC PMFVC Set the preset frequency waiting time for wobble frequency	0.0s (0.0~3600.0s)	STOP
F08.34 (0x0822)	Swing frequency amplitude	V/F SVC FVC PMVF PMSVC PMFVC Set the swing frequency amplitude	10.0% (0.0~50.0%)	STOP
F08.35 (0x0823)	Kick frequency	V/F SVC FVC PMVF PMSVC PMFVC Set kick frequency	10.0% (0.0~50.0%)	STOP
F08.36 (0x0824)	Triangle wave rise time	V/F SVC FVC PMVF PMSVC PMFVC Set triangle wave rise time	5.00s (0.1~999.9s)	STOP
F08.37 (0x0825)	Triangle wave fall time	V/F SVC FVC PMVF PMSVC PMFVC Set triangle wave fall time	5.00s (0.0~100.0s)	STOP

4.12 F09 Group: Reserved

4.13 F10 Group: Protection parameters

F10.0x group: current protection

Parameter code (address)	Name	Content	Factory default (Predetermined area)	Adjustable properties
F10.00 (0x0A00)	Overcurrent suppression function	<p>V/F SVC FVC PMVF PMSVC PMFVC</p> <p>Automatically limit the output current to not exceed the set overcurrent suppression point to prevent excessive current from triggering overcurrent faults.</p> <p>0: inhibition is always effective 1: acceleration / deceleration is effective, constant speed is invalid</p>	0 (0~1)	RUN
F10.01 (0x0A01)	Overcurrent suppression point	<p>V/F SVC FVC PMVF PMSVC PMFVC</p> <p>Set the load current limit level, 100% corresponds to the rated current of the motor.</p>	185.0% (0.0~300.0%)	RUN
F10.02 (0x0A02)	Overcurrent suppression gain	<p>V/F SVC FVC PMVF PMSVC PMFVC</p> <p>Set the response effect of overcurrent suppression.</p>	100.0% (0.0~500.0%)	RUN
F10.03 (0x0A03)	Current protection setting 1	<p>V/F SVC FVC PMVF PMSVC PMFVC</p> <p>Sets whether the current-related protection function is enabled.</p> <p>Ones place: wave-by-wave current limiting (cbc)</p> <p>0: close 1: open</p> <p>Tens place: oc protection interference suppression</p> <p>0: Normal 1: First level interference suppression 2: secondary interference suppression</p> <p>Hundreds: sc protection interference suppression</p> <p>0: Normal 1: First level interference suppression 2: secondary interference suppression</p>	0001 (0000~0221)	STOP

		Thousands: Reserved		
F10.04 (0x0A04)	Current protection setting 2	V/F SVC FVC PMVF PMSVC PMFVC Units: three-phase current and protection options 0: Off 1: On	0001 (0000~0001)	STOP

F10.1x group: voltage protection

Parameter code (address)	Name	Content	Factory default (Predetermined area)	Adjustable properties
F10.10 (0x0A0A)	Bus overvoltage hardware protection function	V/F SVC FVC PMVF PMSVC PMFVC Sets whether the bus overvoltage hardware protection function is enabled 0: Off 1: On	0 (0~1)	STOP
F10.11 (0x0A0B)	Bus overvoltage suppression function	V/F SVC FVC PMVF PMSVC PMFVC When the bus voltage is greater than the overvoltage suppression point, it will slow down or stop acceleration and deceleration to prevent overvoltage fault Units: Overvoltage suppression function 0: close	0012 (0000~0012)	STOP
F10.12 (0x0A0C)	Bus overvoltage suppression point	V/F SVC FVC PMVF PMSVC PMFVC Set the bus voltage value that triggers the overvoltage suppression function	750V (0~820V)	STOP
F10.13 (0x0A0D)	Bus overvoltage suppression gain	V/F SVC FVC PMVF PMSVC PMFVC Setting the response effect of overvoltage suppression	100.0% (0.0~500.0%)	RUN

F10.14 (0x0A0E)	Energy consumption braking enabled	<p>V/F SVC FVC PMVF PMSVC PMFVC</p> <p>Set whether the energy-saving braking function is turned on</p> <p>0: close</p> <p>1: On, but over-voltage suppression is off</p> <p>2: Turn on and turn on the overvoltage suppression function at the same time</p>	2 (0~2)	RUN
F10.15 (0x0A0F)	Energy consumption braking action voltage	<p>V/F SVC FVC PMVF PMSVC PMFVC</p> <p>Set the energy-consumption braking action voltage. When the bus voltage is greater than this value, the energy-consumption braking starts.</p>	740V (0~820V)	RUN
F10.16 (0x0A10)	Bus undervoltage suppression function	<p>V/F SVC FVC PMVF PMSVC PMFVC</p> <p>When the bus voltage is lower than the undervoltage suppression point, the operating frequency is automatically adjusted to suppress the reduction of the bus voltage and prevent undervoltage fault</p> <p>0: Off 1: On</p>	0 (0~1)	STOP
F10.17 (0x0A11)	Bus undervoltage suppression point	<p>V/F SVC FVC PMVF PMSVC PMFVC</p> <p>Set the bus voltage value to trigger the undervoltage suppression function</p>	430V (0~820V)	STOP
F10.18 (0x0A12)	Bus undervoltage suppression gain	<p>V/F SVC FVC PMVF PMSVC PMFVC</p> <p>Setting the response effect of undervoltage suppression</p>	100.0% (0.0~500.0%)	RUN
F10.19 (0x0A13)	Bus undervoltage protection point	<p>V/F SVC FVC PMVF PMSVC PMFVC</p> <p>Allowable lower limit voltage of the set bus voltage, below which the spindle drive reports an undervoltage fault</p>	350V (0~820V)	STOP

F10.2x group: auxiliary protection

Parameter code (address)	Name	Content	Factory default (Predetermined area)	Adjustable properties
F10.20 (0x0A14)	Input and output phase loss protection selection	<p>V/F SVC FVC PMVF PMSVC PMFVC</p> <p>Set whether the input and output phase loss protection function is enabled</p> <p>Unit place: output phase loss protection function 0: Off 1: On</p> <p>Tens place: input phase loss protection function 0: close 1: On, if a phase detection alarm a.1if is detected, continue 2: Turn on, detect input failure and report fault e.1if, stop freely</p>	021 (000~121)	STOP
F10.21 (0x0A15)	Input phase loss threshold	<p>V/F SVC FVC PMVF PMSVC PMFVC</p> <p>Set the voltage detection percentage of the input phase loss detection function, 100% corresponds to the rated bus voltage</p>	10% (0~30.0%)	STOP
F10.22 (0x0A16)	Selection of short-to-ground protection	<p>V/F SVC FVC PMVF PMSVC PMFVC</p> <p>Sets whether the output of the spindle driver and the grounding short circuit protection function of the cooling fan of the spindle driver are enabled.</p> <p>Units: output short-to-ground protection 0: close 1: open</p> <p>Tens place: short-to-ground fan protection 0: close 1: open</p>	11 (00~12)	STOP

F10.23 (0x0A17)	Fan on / off control selection	<p>V/F SVC FVC PMVF PMSVC PMFVC</p> <p>Set the operation mode of the cooling fan of the spindle drive</p> <p>0: Fan runs after the spindle drive is powered on</p> <p>1: After shutdown, the fan operation is related to temperature, and the operation is running</p> <p>2: After stopping, the fan stops after f10.24 time, and the operation is related to temperature</p>	1 (0~2)	RUN
F10.24 (0x0A18)	Fan control delay time	<p>V/F SVC FVC PMVF PMSVC PMFVC</p> <p>Set the time from the deactivation command to the stop of the cooling fan</p>	30.00s (0~600.00)	STOP
F10.25 (0x0A19)	Main shaft driver overheating oH1 warning detection level	<p>V/F SVC FVC PMVF PMSVC PMFVC</p> <p>Set the temperature value of the spindle driver overheating warning.</p>	80.0°C (0~100.0)	RUN

F10.3x group: load protection

Parameter code (address)	Name	Content	Factory default (Predetermined area)	Adjustable properties
F10.30 (0x0A1E)	Motor overload protection curve coefficient	<p>V/F SVC FVC PMVF PMSVC PMFVC</p> <p>Set the coefficient of overload protection for the load motor. Increasing the value can increase the overload capacity of the motor.</p>	100.0% (0~250.0%)	STOP
F10.31 (0x0A1F)	Selection of Overload Characteristics of Spindle Driver at Low Speed	<p>V/F SVC FVC PMVF PMSVC PMFVC</p> <p>Whether the spindle driver overload protection function is effective at low speed (below 5Hz)</p> <p>0: invalid</p> <p>1: valid</p>	0 (0~1)	STOP

		<u>V/F</u> <u>SVC</u> <u>FVC</u> <u>PMVF</u> <u>PMSVC</u> <u>PMFVC</u>		
F10.32 (0x0A20)	Load warning checkout setting	<p>Set the spindle drive load warning detection method and the warning method at this time</p> <p>led single digit: detection option (protection 1)</p> <p>0: No detection</p> <p>1: detection load is too large</p> <p>2: Only at constant speed detects excessive load</p> <p>3: detect insufficient load</p> <p>4: Detect insufficient load only at constant speed</p> <p>5: Detection load is too large (position control is effective)</p> <p>6: detection of insufficient load (position control is effective)</p> <p>led ten place: alarm selection</p> <p>0: Alarm, continue running</p> <p>1: fault protection action and free stop</p> <p>Hundreds of LEDs: detection option (protection 2)</p> <p>0: No detection</p> <p>1: detection load is too large</p> <p>2: Only at constant speed detects excessive load</p> <p>3: detect insufficient load</p> <p>4: Detect insufficient load only at constant speed</p> <p>5: Detection load is too large (position control is effective)</p> <p>6: detection of insufficient load (position control is effective)</p> <p>led thousands: alarm selection</p> <p>0: Alarm, continue running</p> <p>1: fault protection action and free stop</p>	0000 (0000~1414)	STOP
F10.33 (0x0A21)	Load early detection level 1	<p><u>V/F</u> <u>SVC</u> <u>FVC</u> <u>PMVF</u> <u>PMSVC</u> <u>PMFVC</u></p> <p>Set the detection value of load warning 1</p> <p>During vf control, the value 100% corresponds to the rated current of the motor</p>	130.0% (0~200.0%)	STOP

		During vector control, the value 100% corresponds to the rated output torque of the motor		
F10.34 (0x0A22)	Load warning detection time 1	V/F SVC FVC PMVF PMSVC PMFVC Set the duration of the detected load warning 1 and the load will last for this time after the load warning detection level is exceeded.	5.0s (0~60.0)	STOP
F10.35 (0x0A23)	Load early detection level 2	V/F SVC FVC PMVF PMSVC PMFVC Set the detection value of load warning 2 During vf control, the value 100% corresponds to the rated current of the motor During vector control, the value 100% corresponds to the rated output torque of the motor	130.0% (0~200.0%)	STOP
F10.36 (0x0A24)	Load warning detection time 2	V/F SVC FVC PMVF PMSVC PMFVC Set the duration of the detected load warning 2 and it will continue for this time after the load is greater than the load warning detection level.	5.0s (0~60.0)	STOP

Group F10.4x: stall protection

Parameter code	Name	Content	Factory default (Predetermined)	Adjustable properties
F10.40 (0x0A28)	Excessive speed deviation protection action	V/F SVC FVC PMVF PMSVC PMFVC Set the alarm detection mode selection and alarm mode selection when the deviation between the given speed and the feedback speed of the motor is too large Unit: Checkout selection 0: No detection 1: Only at constant speed 2: Always detect Tens place: Alarm selection 0: Stop freely and report fault 1: Alarm and continue running	00 (00~12)	STOP

F10.41 (0x0A29)	Excessive speed deviation detection threshold	<p>V/F SVC FVC PMVF PMSVC PMFVC</p> <p>Set the detection value of excessive speed deviation. The value 100% corresponds to f01.10 [Maximum frequency].</p>	10.0% (0~60.0%)	STOP
F10.42 (0x0A2A)	Excessive speed deviation detection time	<p>V/F SVC FVC PMVF PMSVC PMFVC</p> <p>Set the detection time when the detected speed deviation is too large. If the deviation between the given speed and the feedback speed is greater than f10.41 and continues for this time, the detected speed deviation is too early.</p>	2s (0~60)	STOP
F10.43 (0x0A2B)	Rapid protection action	<p>V/F SVC FVC PMVF PMSVC PMFVC</p> <p>Set the warning detection mode selection and alarm mode selection when the motor is flying fast</p> <p>Unit: Checkout selection</p> <p>0: No detection 1: Only at constant speed 2: Always detect</p> <p>Tens place: Alarm selection</p> <p>0: Stop freely and report fault 1: Alarm and continue running</p>	00 (00~12)	STOP
F10.44 (0x0A2C)	On-the-fly detection threshold	<p>V/F SVC FVC PMVF PMSVC PMFVC</p> <p>Set the speed warning detection value, 100% of this value corresponds to f01.10 [maximum frequency]</p>	110.0% (0~150.0%)	STOP
F10.45 (0x0A2D)	Fast detection time	<p>V/F SVC FVC PMVF PMSVC PMFVC</p> <p>Set the duration of the detection speed, the feedback speed is greater than f10.44 and continues for this time, the detection of speed warning</p>	0.01s (0~2)	STOP

F10.5x Group: Failure Recovery Protection

Parameter code (address)	Name	Content	Factory default (Predetermined area)	Adjustable properties
F10.50 (0x0A32)	Failure self-recovery times	V/F SVC FVC PMVF PMSVC PMFVC Set the number of allowed fault self-recovery. Note: If the value is 0, it means that the fault self-recovery function is disabled, otherwise it means that the function is enabled.	0 (0~10)	STOP
F10.51 (0x0A33)	Failure self-recovery interval	V/F SVC FVC PMVF PMSVC PMFVC Set the waiting time after the spindle drive fails	1.0s (0~100.0)	STOP
F10.52 (0x0A34)	Number of faults recovered	V/F SVC FVC PMVF PMSVC PMFVC Indicates the number of fault self-recoveries that have been performed.	0	READ

4.14 F11: Operator parameters**F11.0x group: key operation**

Parameter code (address)	Name	Content	Factory default (Predetermined area)	Adjustable properties
F11.00 (0x0B00)	Key lock selection	V/F SVC FVC PMVF PMSVC PMFVC 0: Not locked 1: Keyboard function parameter modification lock 2: Function parameter and non-start / stop key lock 3: Function parameters and keys are fully locked	0 (0~3)	RUN
F11.01 (0x0B01)	Key lock password	V/F SVC FVC PMVF PMSVC PMFVC Set key lock password	0 (0~65535)	RUN

<p>F11.04 (0x0B04)</p>	<p>Function selection on the status interface</p>	<p><u>V/F</u> <u>SVC</u> <u>FVC</u> <u>PMVF</u> <u>PMSVC</u> <u>PMFVC</u> Unit: keyboard up and down keys to modify the selection 0: invalid 1: Used to adjust the frequency keyboard reference f01.09 2: Used to adjust the pid keyboard given f13.01 3: keyboard up and down keys to modify parameter number settings Tens place: power-down storage 0: Frequency is not stored when power is off 1: Frequency is stored when power is off Hundreds: motion limitation 0: adjustable operation and shutdown 1: Adjustable only during operation and maintained during shutdown 2: adjustable during operation</p>	<p>0011 (0000~0213)</p>	<p>STOP</p>
<p>F11.05 (0x0B05)</p>	<p>Up and down keys to quickly change parameter code settings</p>	<p><u>V/F</u> <u>SVC</u> <u>FVC</u> <u>PMVF</u> <u>PMSVC</u> <u>PMFVC</u> Tens place digits: yy setting in function parameter number Fxx.yy 00~99 Hundreds and thousands: xx setting in function parameter number Fxx.yy 00~15</p>	<p>0109 (0000~1563)</p>	<p>RUN</p>

F11.1x group: cyclic monitoring of status interface

Parameter code (address)	Name	Content	Factory default (Predetermined area)	Adjustable properties
--------------------------	------	---------	--------------------------------------	-----------------------

F11.11 (0x0B0B)	The first line of the keyboard displays the parameters cyclically	<p>V/F SVC FVC PMVF PMSVC PMFVC</p> <p>Tens place digits: yy setting in monitoring parameter number Cxx.yy 00~63</p> <p>Hundreds and thousands: xx setting in monitoring parameter number Cxx.yy 00~07</p>	0000 (0000~0763)	RUN
F11.12 (0x0B0C)	The first line of the keyboard displays the parameters cyclically 2	<p>V/F SVC FVC PMVF PMSVC PMFVC</p> <p>lbid</p>	0001 (0000~0763)	RUN
F11.13 (0x0B0D)	The first line of the keyboard cycle display parameter 3	<p>V/F SVC FVC PMVF PMSVC PMFVC</p> <p>lbid</p>	0002 (0000~0763)	RUN
F11.14 (0x0B0E)	The first line of the keyboard displays the parameters cyclically4	<p>V/F SVC FVC PMVF PMSVC PMFVC</p> <p>lbid</p>	0011 (0000~0763)	RUN

F11.2x group: monitoring parameter control

Parameter code (address)	Name	Content	Factory default (Predetermined area)	Adjustable properties
F11.20 (0x0B14)	Keyboard display item settings	<p>V/F SVC FVC PMVF PMSVC PMFVC</p> <p>Unit place: output frequency display selection</p> <p>0: target frequency</p> <p>1: running frequency> =</p> <p>2: target frequency, filtering depth becomes larger with this value</p> <p>Tens place: Reserved</p> <p>0: invalid</p>	0002 (0000~111f)	RUN

		<p>1: Remove active power from stator resistance</p> <p>Hundreds place: Power display dimension</p> <p>0: Power display percentage (%)</p> <p>1: Power display kilowatt (kw)</p> <p>Thousands: Reserved</p>		
F11.21 (0x0B15)	Speed display factor	<p>V/F SVC FVC PMVF PMSVC PMFVC</p> <p>Adjust the display of c00.06 speed.</p>	100.0% (0.0~500.0%)	RUN
F11.22 (0x0B16)	Power display factor	<p>V/F SVC FVC PMVF PMSVC PMFVC</p> <p>Adjust the display of c00.10 output power.</p>	100.0% (0.0~500.0%)	RUN
F11.23 (0x0B17)	Monitoring parameter group display select	<p>V/F SVC FVC PMVF PMSVC PMFVC</p> <p>Units: Reserved</p> <p>0: invalid 1: valid</p> <p>Tens place: c05 display selection</p> <p>0: Automatically switch according to the control mode</p> <p>1: vf mode related parameters</p> <p>2: vc mode related parameters</p> <p>Hundreds: c00.40 ~ c00.63 display selection</p> <p>0: Not displayed 1: Displayed</p> <p>Thousands: communication fault code switching enabled</p> <p>0: Disable</p> <p>1: enable</p>	0000 (0000~FFFF)	RUN
F11.24 (0x0B18)	Monitoring parameter filtering selection	<p>V/F SVC FVC PMVF PMSVC PMFVC</p> <p>Units: output current display filtering</p> <p>0 ~ f: The larger the value, the deeper the filtering</p>	0x0000 (0x0000~0x000F)	RUN

F11.25 (0x0B19)	Display selection during motor self-learning	V/F SVC FVC PMVF PMSVC PMFVC Display selection when setting motor self-learning 0: Show the status of the self-learning process 1: Do not display the status of the self-learning process	0 (0~1)	STOP
F11.27 (0x0B1B)	Fault display selection	V/F SVC FVC PMVF PMSVC PMFVC Single digit: display fault when fault self-recovery 0: Not displayed 1: display	0x0001 (0x0000~ 0x0001)	RUN

F11.3x Group: Reserved**4.15 F12: Communication parameters****F12.0x group: MODBUS slave parameters**

Parameter code (address)	Name	Content	Factory default (Predetermined area)	Adjustable properties
F12.00 (0x0C00)	Master-slave selection	V/F SVC FVC PMVF PMSVC PMFVC 0: slave, 1: master	0 (0~1)	STOP
F12.01 (0x0C01)	Modbus communication	V/F SVC FVC PMVF PMSVC PMFVC Set different values for different slaves.	1 (1~247)	STOP
F12.02 (0x0C02)	Communication baud rate selection	V/F SVC FVC PMVF PMSVC PMFVC 0: 1200 bps 1: 2400 bps 2: 4800 bps 3: 9600 bps 4: 19200 bps 5: 38400 bps 6: 57600 bps	3 (0~6)	STOP

F12.03 (0x0C03)	Modbus data format	<p>V/F SVC FVC PMVF PMSVC PMFVC</p> <p>0: (n, 8,1) without checksum, Data bits: 8, Stop bits: 1</p> <p>1: (e, 8,1) even parity, Data bits: 8, Stop bits: 1</p> <p>2: (o, 8,1) odd parity, Data bits: 8, Stop bits: 1</p> <p>3: (n, 8,2) without checksum, Data bits: 8, Stop bits: 2</p> <p>4: (e, 8,2) even parity, Data bits: 8, Stop bits: 2</p> <p>5: (o, 8,2) odd parity, Data bits: 8, Stop bits: 2</p>	0 (0~5)	STOP
F12.04 (0x0C04)	Modbus transmission response processing	<p>V/F SVC FVC PMVF PMSVC PMFVC</p> <p>0: Write operation has response 1: Write operation has no response</p>	0 (0~1)	RUN
F12.05 (0x0C05)	Modbus communication response delay	<p>V/F SVC FVC PMVF PMSVC PMFVC</p> <p>Set Modbus communication response delay</p>	0ms (0~500ms)	RUN
F12.06 (0x0C06)	Modbus communication timeout failure time	<p>V/F SVC FVC PMVF PMSVC PMFVC</p> <p>Set Modbus communication timeout failure time</p>	1.0s (0.1~100s)	RUN
F12.07 (0x0C07)	Communication disconnection processing	<p>V/F SVC FVC PMVF PMSVC PMFVC</p> <p>0: Do not detect timeout failure 1: Failure and free stop</p>	0 (0~3)	RUN

F12.08 (0x0C08)	Received data (address 0x3000)	V/F SVC FVC PMVF PMSVC PMFVC Offset the communication data at address 0x3000.	0.00 (-100.00-100.00)	RUN
F12.09 (0x0C09)	Receive data (address 0x3000) gain	V/F SVC FVC PMVF PMSVC PMFVC Linearize the communication data at address 0x3000.	100.0% (0.0~500.0%)	RUN

F12.1x group: MODBUS host parameters

Parameter code (address)	Name	Content	Factory default (Predetermined area)	Adjustable properties
F12.10 (0x0C0A)	Host cycle sending parameter selection	V/F SVC FVC PMVF PMSVC PMFVC One, ten, one hundred, one thousand 0: invalid 1: host run command 2: host given frequency 3: Host output frequency 4: Host upper limit frequency 5: host given torque 6: Host output torque 7: Reserved 8: Reserved 9: host pid given a: host pid feedback b: Reserved c: Active current component	0031 (0000~CCCC)	RUN
F12.11 (0x0C0B)	Frequency given custom address	V/F SVC FVC PMVF PMSVC PMFVC Set the frequency to give a custom address	0000 (0000~FFFF)	RUN

F12.12 (0x0C0C)	Command given custom address setting	V/F SVC FVC PMVF PMSVC PMFVC Set command to give a custom address	0000 (0000~FFFF)	RUN
F12.13 (0x0C0D)	The command is given as the forward run command value	V/F SVC FVC PMVF PMSVC PMFVC Set command is given as forward run command value	0001 (0000~FFFF)	RUN
F12.14 (0x0C0E)	Command given as reverse run command value	V/F SVC FVC PMVF PMSVC PMFVC Set command is given as reverse run command value	0002 (0000~FFFF)	RUN
F12.15 (0x0C0F)	Command given as stop command value	V/F SVC FVC PMVF PMSVC PMFVC Setting command is given as stop command value	0005 (0000~FFFF)	RUN
F12.16 (0x0C10)	Command given as reset command value	V/F SVC FVC PMVF PMSVC PMFVC Set command is given as reset command value	0007 (0000~FFFF)	RUN

4.16 f13: Process PID control

f13.00-f13.06: PID given and feedback

Parameter code (address)	Name	Content	Factory default (Predetermined area)	Adjustable properties
F13.00 (0x0D00)	PID controller given signal source	V/F SVC FVC PMVF PMSVC PMFVC 0: keyboard number pid given 1: keyboard analog potentiometer given 2: current / voltage analog ai1 given 3: current / voltage analog ai2 given 4: Reserved 5: terminal pulse pul given 6: rs485 communication given 7: optional card 8: terminal selection 9: Communication given active current	0 (0~9)	RUN

F13.01 (0x0D01)	Keyboard number pid given / feedback	V/F SVC FVC PMVF PMSVC PMFVC Set keyboard number pid given / feedback value	50.0% (0.00~100.0%)	RUN
F13.02 (0x0D02)	pid given change time	V/F SVC FVC PMVF PMSVC PMFVC Set pid given change time	1.00s (0.00~60.00s)	RUN
F13.03 (0x0D03)	PID controller feedback signal source	V/F SVC FVC PMVF PMSVC PMFVC 0: keyboard digital pid feedback 1: keyboard analog potentiometer feedback 2: current / voltage analog ai1 feedback 3: current / voltage analog ai2 feedback 4: Reserved 5: terminal pulse pul feedback 6: rs485 communication feedback 7: optional card 8: terminal selection 9: Local active current	2 (0~9)	RUN
F13.04 (0x0D04)	Low-pass filtering time of feedback signal	V/F SVC FVC PMVF PMSVC PMFVC Set the low-pass filtering time of the feedback signal	0.010s (0.000~6.000s)	RUN
F13.05 (0x0D05)	Feedback signal gain	V/F SVC FVC PMVF PMSVC PMFVC Setting the feedback signal gain	1.00 (0.00~10.00)	RUN
F13.06 (0x0D06)	Feedback signal range	V/F SVC FVC PMVF PMSVC PMFVC Set the feedback signal range	100.0 (0~100.0)	RUN

f13.07-f13.24: pid adjustment

Parameter code (address)	Name	Content	Factory default (Predetermined area)	Adjustable properties
F13.07 (0x0D07)	pid control selection	V/F SVC FVC PMVF PMSVC PMFVC Unit place: feedback feature selection	0000 (0000~1111)	RUN

SD500spindle servo driver

		<p>0: Positive characteristic 1: negative characteristics</p> <p>Tens place: Reserved Hundreds: Reserved Thousands: Differential Adjustment Properties</p> <p>0: Differentiate the deviation 1: Differentiate feedback</p>		
F13.08 (0x0D08)	pid preset output	<p>V/F SVC FVC PMVF PMSVC PMFVC</p> <p>Set pid preset output</p>	100.0% (0.0~100.0%)	RUN
F13.09 (0x0D09)	pid preset output run time	<p>V/F SVC FVC PMVF PMSVC PMFVC</p> <p>Set pid preset output running time</p>	0.0s (0.0~6500.0s)	RUN
F13.10 (0x0D0A)	pid control deviation limit	<p>V/F SVC FVC PMVF PMSVC PMFVC</p> <p>Set pid control deviation limit</p>	0.0% (0.0~100.0%)	RUN
F13.11 (0x0D0B)	Proportional gain p1	<p>V/F SVC FVC PMVF PMSVC PMFVC</p> <p>Set proportional gain p1</p>	0.100 (0.000~4.000)	RUN
F13.12 (0x0D0C)	Integration time i1	<p>V/F SVC FVC PMVF PMSVC PMFVC</p> <p>Set integration time i1</p>	1.0s (0.0~600.0s)	RUN
F13.13	Differential gain d1	<p>V/F SVC FVC PMVF PMSVC PMFVC</p>	0.000s	RUN
F13.14	Proportional gain p2	<p>V/F SVC FVC PMVF PMSVC PMFVC</p>	0.100	RUN
F13.15 (0x0D0F)	Integration time i2	<p>V/F SVC FVC PMVF PMSVC PMFVC</p> <p>Set integration time i2</p>	1.0s (0.0~600.0s)	RUN
F13.16 (0x0D10)	Differential gain d2	<p>V/F SVC FVC PMVF PMSVC PMFVC</p> <p>Set differential gain d2</p>	0.000s (0.000~6.000s)	RUN
F13.17 (0x0D11)	pid parameter switching conditions	<p>V/F SVC FVC PMVF PMSVC PMFVC</p> <p>0: Do not switch 1: use di terminal to switch 2: switch based on deviation</p>	0 (0~2)	RUN
F13.18 (0x0D12)	Low switching deviation	<p>V/F SVC FVC PMVF PMSVC PMFVC</p> <p>Set the switching deviation low value, when the pid deviation is less than this value, use the gain 1 parameter</p>	20.0% (0.0~100.0%)	RUN

F13.19 (0x0D13)	High switching deviation	V/F SVC FVC PMVF PMSVC PMFVC Set the switching deviation high value, when the pid deviation is greater than this value, use the gain 2 parameter	80.0% (0.0~100.0%)	RUN
F13.21 (0x0D15)	Differential clipping	V/F SVC FVC PMVF PMSVC PMFVC Set differential limit	5.0% (0.0~100.0%)	RUN
F13.22 (0x0D16)	pid output upper limit	V/F SVC FVC PMVF PMSVC PMFVC Set the maximum pid output	100.0% (0.0~100.0%)	RUN
F13.23 (0x0D17)	pid output lower limit	V/F SVC FVC PMVF PMSVC PMFVC Set pid output lower limit	0.0% (-100.0~ F13.22)	RUN
F13.24 (0x0D18)	pid output filter time	V/F SVC FVC PMVF PMSVC PMFVC Set pid output filter time	0.000s (0.000~6.000s)	RUN

f13.25-f13.28: PID disconnection judgment

Parameter code	Name	Content	Factory default (Predetermined)	Adjustable properties
F13.25 (0x0D19)	Feedback disconnection action selection	V/F SVC FVC PMVF PMSVC PMFVC 0: Continue pid operation without failure 1: Stop and report failure 2: Continue pid operation, output alarm signal 3: Run at current frequency, output alarm signal	0 (0~3)	STOP
F13.26 (0x0D1A)	Feedback disconnection detection time	V/F SVC FVC PMVF PMSVC PMFVC Set feedback disconnection detection time	1.0s (0.0~120.0s)	RUN
F13.27 (0x0D1B)	Disconnection alarm upper limit	V/F SVC FVC PMVF PMSVC PMFVC Set the upper limit of disconnection alarm	100.0 (0.0~100.0%)	RUN
F13.28 (0x0D1C)	Disconnection alarm lower limit	V/F SVC FVC PMVF PMSVC PMFVC Set the lower limit of disconnection alarm	0.0% (0.0~100.0%)	RUN

f13.29-f13.33: pid sleep function

Parameter code (address)	Name	Content	Factory default (Predetermined area)	Adjustable properties
F13.29 (0x0D1D)	Sleep choice	<input type="checkbox"/> V <input type="checkbox"/> F <input type="checkbox"/> SVC <input type="checkbox"/> FVC <input type="checkbox"/> PMVF <input type="checkbox"/> PMSVC <input type="checkbox"/> PMFVC Set whether sleep is effective 0: Disable 1: Enable	0 (0~1)	RUN
F13.30 (0x0D1E)	Sleep frequency	<input type="checkbox"/> V <input type="checkbox"/> F <input type="checkbox"/> SVC <input type="checkbox"/> FVC <input type="checkbox"/> PMVF <input type="checkbox"/> PMSVC <input type="checkbox"/> PMFVC Set sleep frequency	10.00Hz (0.00 ~ max frequency)	RUN
F13.31 (0x0D1F)	Sleep delay	<input type="checkbox"/> V <input type="checkbox"/> F <input type="checkbox"/> SVC <input type="checkbox"/> FVC <input type="checkbox"/> PMVF <input type="checkbox"/> PMSVC <input type="checkbox"/> PMFVC Set sleep delay	60.0S (0.0~3600.0S)	RUN
F13.32 (0x0D20)	Wake-up bias	<input type="checkbox"/> V <input type="checkbox"/> F <input type="checkbox"/> SVC <input type="checkbox"/> FVC <input type="checkbox"/> PMVF <input type="checkbox"/> PMSVC <input type="checkbox"/> PMFVC Set wakeup bias	5.0% (0.0~50.0%)	RUN
F13.33 (0x0D21)	Wake-up delay	<input type="checkbox"/> V <input type="checkbox"/> F <input type="checkbox"/> SVC <input type="checkbox"/> FVC <input type="checkbox"/> PMVF <input type="checkbox"/> PMSVC <input type="checkbox"/> PMFVC Set wake-up delay	1.0S (0.0~60.0S)	RUN

4.17 f14: Multi-speed and simple plc

f14.00 ~ f14.14: Multi-speed frequency reference

Parameter code (address)	Name	Content	Factory default (Predetermined area)	Adjustable properties
F14.00 (0x0E00)	plc multi-speed 1	<input type="checkbox"/> V <input type="checkbox"/> F <input type="checkbox"/> SVC <input type="checkbox"/> FVC <input type="checkbox"/> PMVF <input type="checkbox"/> PMSVC <input type="checkbox"/> PMFVC Set plc multi-speed 1	10.00Hz (0.00 ~ max frequency)	RUN
F14.01 (0x0E01)	plc multi-speed 2	<input type="checkbox"/> V <input type="checkbox"/> F <input type="checkbox"/> SVC <input type="checkbox"/> FVC <input type="checkbox"/> PMVF <input type="checkbox"/> PMSVC <input type="checkbox"/> PMFVC Set plc multi-speed 2	20.00Hz (0.00 ~ max frequency)	RUN
F14.02 (0x0E02)	plc multi-speed 3	<input type="checkbox"/> V <input type="checkbox"/> F <input type="checkbox"/> SVC <input type="checkbox"/> FVC <input type="checkbox"/> PMVF <input type="checkbox"/> PMSVC <input type="checkbox"/> PMFVC Set plc multi-speed 3	30.00Hz (0.00 ~ max frequency)	RUN
F14.03 (0x0E03)	plc multi-speed 4	<input type="checkbox"/> V <input type="checkbox"/> F <input type="checkbox"/> SVC <input type="checkbox"/> FVC <input type="checkbox"/> PMVF <input type="checkbox"/> PMSVC <input type="checkbox"/> PMFVC Set plc multi-speed 4	40.00Hz (0.00 ~ max frequency)	RUN

			frequency)	
F14.04 (0x0E04)	plc multi-speed 5	V/F SVC FVC PMVF PMSVC PMFVC Set plc multi-speed 5	50.00Hz (0.00 ~ max frequency)	RUN
F14.05 (0x0E05)	plc multi-speed 6	V/F SVC FVC PMVF PMSVC PMFVC Set plc multi-speed 6	40.00Hz (0.00 ~ max frequency)	RUN
F14.06 (0x0E06)	plc multi-speed 7	V/F SVC FVC PMVF PMSVC PMFVC Set plc multi-speed 7	30.00Hz (0.00 ~ max frequency)	RUN
F14.07 (0x0E07)	plc multi-speed 8	V/F SVC FVC PMVF PMSVC PMFVC Set plc multi-speed 8	20.00Hz (0.00 ~ max frequency)	RUN
F14.08 (0x0E08)	plc multi-speed 9	V/F SVC FVC PMVF PMSVC PMFVC Set plc multi-speed 9	10.00Hz (0.00 ~ max frequency)	RUN
F14.09 (0x0E09)	plc multi-speed 10	V/F SVC FVC PMVF PMSVC PMFVC Set plc multi-speed 10	20.00Hz (0.00 ~ max frequency)	RUN
F14.10 (0x0E0A)	plc multi-speed 11	V/F SVC FVC PMVF PMSVC PMFVC Set plc multi-speed 11	30.00Hz (0.00 ~ max frequency)	RUN
F14.11 (0x0E0B)	plc multi-speed 12	V/F SVC FVC PMVF PMSVC PMFVC Set plc multi-speed 12	40.00Hz (0.00 ~ max frequency)	RUN
F14.12 (0x0E0C)	plc multi-speed 13	V/F SVC FVC PMVF PMSVC PMFVC Set plc multi-speed 13	50.00Hz (0.00 ~ max frequency)	RUN
F14.13 (0x0E0D)	plc multi-speed 14	V/F SVC FVC PMVF PMSVC PMFVC Set plc multi-speed 14	40.00Hz (0.00 ~ max frequency)	RUN
F14.14 (0x0E0E)	plc multi-speed 15	V/F SVC FVC PMVF PMSVC PMFVC Set plc multi-speed 15	30.00Hz (0.00 ~ max frequency)	RUN

			frequency)	
--	--	--	------------	--

F14. 15: plc operation mode selection

Parameter code (address)	Name	Content	Factory default (Predetermined area)	Adjustable properties
F14.15 (0x0E0F)	plc operation mode selection	<p>V/F SVC FVC PMVF PMSVC PMFVC</p> <p>Units: circular mode</p> <p>0: Stop after single cycle</p> <p>1: continuous loop</p> <p>2: Keep the final value after a single cycle</p> <p>Ten place: timing unit</p> <p>0: second 1: minute 2: hour</p> <p>Hundreds place: power-down storage method</p> <p>0: Not stored 1: Stored</p> <p>Thousands: start method</p> <p>0: Re-run from the first stage</p> <p>1: Re-run from the stage of downtime</p> <p>2: Continue to run with the remainder of the downtime phase</p>	0000 (0000~2122)	RUN

f14.16 ~ f14.30: plc running time selection

Parameter code (address)	Name	Content	Factory default (Predetermined area)	Adjustable properties
F14.16 (0x0E10)	plc paragraph 1 operation time	<p>V/F SVC FVC PMVF PMSVC PMFVC</p> <p>Set plc run time</p>	10.0 (0.0~ 6500.0(s/m/h))	RUN
F14.17 (0x0E11)	plc paragraph 2 operation	<p>V/F SVC FVC PMVF PMSVC PMFVC</p> <p>Set plc stage 2 run time</p>	10.0 (0.0~	RUN
F14.18 (0x0E12)	plc paragraph 3 operation	<p>V/F SVC FVC PMVF PMSVC PMFVC</p> <p>Set plc stage 3 run time</p>	10.0 (0.0~	RUN

SD500spindle servo driver

	time		6500.0(s/m/h))	
F14.19 (0x0E13)	plc paragraph 4 operation time	V/F SVC FVC PMVF PMSVC PMFVC Set plc stage 4 run time	10.0 (0.0~ 6500.0(s/m/h))	RUN
F14.20 (0x0E14)	plc paragraph 5 operation time	V/F SVC FVC PMVF PMSVC PMFVC Set plc stage 5 run time	10.0 (0.0~ 6500.0(s/m/h))	RUN
F14.21 (0x0E15)	plc paragraph 6 operation time	V/F SVC FVC PMVF PMSVC PMFVC Set plc stage 6 run time	10.0 (0.0~ 6500.0(s/m/h))	RUN
F14.22 (0x0E16)	plc paragraph 7 operation	V/F SVC FVC PMVF PMSVC PMFVC Set plc 7th run time	10.0 (0.0~	RUN
F14.23 (0x0E17)	plc 8th run time	V/F SVC FVC PMVF PMSVC PMFVC Set plc segment 8 run time	10.0 (0.0~	RUN
F14.24 (0x0E18)	plc paragraph 9 operation time	V/F SVC FVC PMVF PMSVC PMFVC Set plc 9th run time	10.0 (0.0~ 6500.0(s/m/h))	RUN
F14.25 (0x0E19)	plc paragraph 10 operation time	V/F SVC FVC PMVF PMSVC PMFVC Set PLC 10th run time	10.0 (0.0~ 6500.0(s/m/h))	RUN
F14.26 (0x0E1A)	plc paragraph 11 operation time	V/F SVC FVC PMVF PMSVC PMFVC Set plc run time	10.0 (0.0~ 6500.0(s/m/h))	RUN
F14.27 (0x0E1B)	plc paragraph 12 operation time	V/F SVC FVC PMVF PMSVC PMFVC Set plc 12th run time	10.0 (0.0~ 6500.0(s/m/h))	RUN
F14.28 (0x0E1C)	plc paragraph 13 operation time	V/F SVC FVC PMVF PMSVC PMFVC Set plc 13th run time	10.0 (0.0~ 6500.0(s/m/h))	RUN
F14.29 (0x0E1D)	plc paragraph 14 operation time	V/F SVC FVC PMVF PMSVC PMFVC Set plc segment 14 run time	10.0 (0.0~ 6500.0(s/m/h))	RUN
F14.30	plc paragraph 15	V/F SVC FVC PMVF PMSVC PMFVC	10.0	RUN

(0x0E1E)	operation time	Set plc 15th run time	(0.0~ 6500.0(s/m/h))	
----------	-------------------	-----------------------	-------------------------	--

f14.31 ~ f14.45: plc running direction and time selection

Parameter code (address)	Name	Content	Factory default (Predetermined area)	Adjustable properties
F14.31 (0x0E1F)	plc direction and acceleration / deceleration time	<p>V/F SVC FVC PMVF PMSVC PMFVC</p> <p>Units: running direction of this paragraph (compared with running command)</p> <p>0: Same direction 1: Reverse</p> <p>Tens place: acceleration / deceleration time of this paragraph</p> <p>0: Acceleration / deceleration time 1</p> <p>1: acceleration / deceleration time 2</p> <p>2: Acceleration / deceleration time 3</p> <p>3: acceleration / deceleration time 4</p>	0000 (0000~0031)	RUN
F14.32 (0x0E20)	plc step 2 direction and acceleration / deceleration time	<p>V/F SVC FVC PMVF PMSVC PMFVC</p> <p>Settings are the same as f14.31</p>	0000 (0000~0031)	RUN
F14.33 (0x0E21)	plc paragraph 3 direction and acceleration / deceleration time	<p>V/F SVC FVC PMVF PMSVC PMFVC</p> <p>Settings are the same as f14.31</p>	0000 (0000~0031)	RUN
F14.34 (0x0E22)	plc step 4 direction and acceleration / deceleration time	<p>V/F SVC FVC PMVF PMSVC PMFVC</p> <p>Settings are the same as f14.31</p>	0000 (0000~0031)	RUN
F14.35 (0x0E23)	plc paragraph 5 direction and acceleration / deceleration time	<p>V/F SVC FVC PMVF PMSVC PMFVC</p> <p>Settings are the same as f14.31</p>	0000 (0000~0031)	RUN

F14.36 (0x0E24)	plc paragraph 6 direction and acceleration / deceleration time	<input type="checkbox"/> V/F <input type="checkbox"/> SVC <input type="checkbox"/> FVC <input type="checkbox"/> PMVF <input type="checkbox"/> PMSVC <input type="checkbox"/> PMFVC Settings are the same as f14.31	0000 (0000~0031)	RUN
F14.37 (0x0E25)	plc paragraph 7 direction and acceleration /	<input type="checkbox"/> V/F <input type="checkbox"/> SVC <input type="checkbox"/> FVC <input type="checkbox"/> PMVF <input type="checkbox"/> PMSVC <input type="checkbox"/> PMFVC Settings are the same as f14.31	0000 (0000~0031)	RUN
F14.38 (0x0E26)	plc paragraph 8 direction and acceleration /	<input type="checkbox"/> V/F <input type="checkbox"/> SVC <input type="checkbox"/> FVC <input type="checkbox"/> PMVF <input type="checkbox"/> PMSVC <input type="checkbox"/> PMFVC Settings are the same as f14.31	0000 (0000~0031)	RUN
F14.39 (0x0E27)	plc paragraph 9 direction and acceleration / deceleration time	<input type="checkbox"/> V/F <input type="checkbox"/> SVC <input type="checkbox"/> FVC <input type="checkbox"/> PMVF <input type="checkbox"/> PMSVC <input type="checkbox"/> PMFVC Settings are the same as f14.31	0000 (0000~0031)	RUN
F14.40 (0x0E28)	plc paragraph 10 direction and acceleration / deceleration time	<input type="checkbox"/> V/F <input type="checkbox"/> SVC <input type="checkbox"/> FVC <input type="checkbox"/> PMVF <input type="checkbox"/> PMSVC <input type="checkbox"/> PMFVC Settings are the same as f14.31	0000 (0000~0031)	RUN
F14.41 (0x0E29)	plc section 11 direction and acceleration / deceleration time	<input type="checkbox"/> V/F <input type="checkbox"/> SVC <input type="checkbox"/> FVC <input type="checkbox"/> PMVF <input type="checkbox"/> PMSVC <input type="checkbox"/> PMFVC Settings are the same as f14.31	0000 (0000~0031)	RUN
F14.42 (0x0E2A)	plc paragraph 12 direction and acceleration / deceleration time	<input type="checkbox"/> V/F <input type="checkbox"/> SVC <input type="checkbox"/> FVC <input type="checkbox"/> PMVF <input type="checkbox"/> PMSVC <input type="checkbox"/> PMFVC Settings are the same as f14.31	0000 (0000~0031)	RUN
F14.43 (0x0E2B)	plc paragraph 13 direction and acceleration / deceleration time	<input type="checkbox"/> V/F <input type="checkbox"/> SVC <input type="checkbox"/> FVC <input type="checkbox"/> PMVF <input type="checkbox"/> PMSVC <input type="checkbox"/> PMFVC Settings are the same as f14.31	0000 (0000~0031)	RUN
F14.44 (0x02C)	plc paragraph 14 direction and acceleration /	<input type="checkbox"/> V/F <input type="checkbox"/> SVC <input type="checkbox"/> FVC <input type="checkbox"/> PMVF <input type="checkbox"/> PMSVC <input type="checkbox"/> PMFVC Settings are the same as f14.31	0000 (0000~0031)	RUN

	deceleration time			
F14.45 (0x0E2D)	plc paragraph 15 direction and acceleration / deceleration time	V/F SVC FVC PMVF PMSVC PMFVC Settings are the same as f14.31	0000 (0000~0031)	RUN

4.18 f15: Position control

Parameter code (address)	Name	Content	Factory default (Predetermined area)	Adjustable properties
F15.00 (0x0F00)	Position control mode selection	V/F SVC FVC PMVF PMSVC PMFVC 0: Off 1: On	0 (0~1)	RUN
F15.01	Pulse position	V/F SVC FVC PMVF PMSVC PMFVC	2	RUN
F15.02 (0x0F02)	Pulse counting mode	V/F SVC FVC PMVF PMSVC PMFVC 0:AB; 1:CW+CCW; 2: pulse + direction; 3: Reserved; 4: ab reverse; 5: cw + ccw reverse; 6: Pulse + direction inversion; 7: Reserved;	4 (0~7)	STOP
F15.03 (0x0F03)	Keyboard number given	V/F SVC FVC PMVF PMSVC PMFVC Set keyboard given pulse amount	0 (0~65535)	RUN
F15.04 (0x0F04)	Electronic gear molecule	V/F SVC FVC PMVF PMSVC PMFVC Setting the electronic gear ratio numerator	1 (1~32767)	STOP
F15.05 (0x0F05)	Electronic Gear Denominator	V/F SVC FVC PMVF PMSVC PMFVC Set electronic gear ratio denominator	1 (1~32767)	STOP
F15.06 (0x0F06)	Position given first order filtering time	V/F SVC FVC PMVF PMSVC PMFVC Used to filter the input position command to make	0.0 (0.0~)	STOP
F15.07 (0x0F07)	Position given smoothing filter time	V/F SVC FVC PMVF PMSVC PMFVC Used to filter the input position command to make	0.1 (0.0~)	STOP

SD500spindle servo driver

F15.08 (0x0F08)	Speed feedforward gain	V/F SVC FVC PMVF PMSVC PMFVC Used to improve system dynamic operation followability	100.0% (0.0%~300.0%)	RUN
F15.09 (0x0F09)	Speed feedforward filtering time	V/F SVC FVC PMVF PMSVC PMFVC Filter command pulse signal to improve anti-interference	1.0 (0.0~100.0ms)	RUN
F15.10 (0x0F0A)	Position controller output limiter	V/F SVC FVC PMVF PMSVC PMFVC Set output limit value of position proportional controller	100.0% (0.0%~100.0%)	RUN
F15.11 (0x0F0B)	Position loop proportional gain 1	V/F SVC FVC PMVF PMSVC PMFVC For improved system response and rigidity	50.0 (0.0~600.0Hz)	RUN
F15.12 (0x0F0C)	Position loop proportional gain 2	V/F SVC FVC PMVF PMSVC PMFVC For improved system response and rigidity	30.0 (0.0~600.0Hz)	RUN
F15.13 (0x0F0D)	Gain switching mode	V/F SVC FVC PMVF PMSVC PMFVC 0: Not switched 1: Terminal switched 2: Position error 3: Speed error	0 (0~3)	STOP
F15.14 (0x0F0E)	Switching filter time	V/F SVC FVC PMVF PMSVC PMFVC For adjusting the smooth switching position loop gain	0.030 (0.000~6.000s)	STOP
F15.15 (0x0F0F)	Switching position error	V/F SVC FVC PMVF PMSVC PMFVC Set the position error value of the switching gain	10 (1~32767)	RUN
F15.16 (0x0F10)	Switch speed command	V/F SVC FVC PMVF PMSVC PMFVC Set the speed value of the switching gain	0.00Hz (0.00 ~ maximum frequency digital setting)	RUN
F15.17 (0x0F11)	Location positioning completion conditions	V/F SVC FVC PMVF PMSVC PMFVC 0: The absolute value of the position deviation is smaller than the positioning completion range 1: The absolute value of the position deviation is less than the positioning completion range and the	0 (0~1)	RUN

SD500spindle servo driver

		position command is zero		
F15.18 (0x0F12)	Position positioning completion width	V/F SVC FVC PMVF PMSVC PMFVC Set positioning completion judgment threshold	10 (1~32767)	RUN
F15.19 (0x0F13)	Position close to width	V/F SVC FVC PMVF PMSVC PMFVC When the absolute value of the position deviation is less than the position approach width, the output terminal "position approach" outputs a valid signal	100 (1~32767)	RUN
F15.20 (0x0F14)	Zero servo action error	V/F SVC FVC PMVF PMSVC PMFVC Set zero servo action deviation threshold	0 (0~1000)	RUN
F15.21 (0x0F15)	Position tolerance action selection	V/F SVC FVC PMVF PMSVC PMFVC 0: Position error is not detected 1: Position out-of-tolerance detection is valid, and an alarm signal is output 2: Position out-of-tolerance detection is valid, and fault signal is output	0 (0~2)	RUN
F15.22 (0x0F16)	Position out-of- tolerance detection frequency	V/F SVC FVC PMVF PMSVC PMFVC Set the position out-of-tolerance detection frequency threshold	110.0% (0.0%~ 200.0%)	RUN
F15.23 (0x0F17)	Position out-of- tolerance detection time	V/F SVC FVC PMVF PMSVC PMFVC Set position out-of-tolerance detection time	10ms (0~6000ms)	STOP
F15.24 (0x0F18)	Servo stop mode	V/F SVC FVC PMVF PMSVC PMFVC 0: Stop after entering positioning 1: Switch the control mode to speed control mode and stop at zero speed	0 (0~1)	STOP
F15.25 (0x0F19)	Position control asr proportional gain	V/F SVC FVC PMVF PMSVC PMFVC For improved system response and rigidity	30.00 (0.01~ 100.00)	RUN
F15.26 (0x0F1A)	Position control asr integration time	V/F SVC FVC PMVF PMSVC PMFVC For improved system response and rigidity	0.050s (0.000~ 6.000s)	RUN
F15.28 (0x0F1C)	Gear ratio pulse number numerator	V/F SVC FVC PMVF PMSVC PMFVC Set the number of molecular encoder pulses in the	1000 (0~65535)	RUN

		gear ratio		
F15.29 (0x0F1D)	Gear ratio pulse number denominator	V/F SVC FVC PMVF PMSVC PMFVC Set the number of denominator encoder pulses in the gear ratio	1000 (0~65535)	RUN
F15.30 (0x0F1E)	Keep	V/F SVC FVC PMVF PMSVC PMFVC	0	STOP
F15.31 (0x0F1F)	z pulse width extension	V/F SVC FVC PMVF PMSVC PMFVC Hundreds place: Spindle encoder Thousands place: Motor encoder 0: no action 1: z pulse extension	1100 (0000~1111)	STOP
F15.32 (0x0F20)	adrc observer gain $\beta 1$	V/F SVC FVC PMVF PMSVC PMFVC For improved system response and rigidity	10000 (0~20000)	RUN
F15.33 (0x0F21)	adrc observer gain $\beta 2$	V/F SVC FVC PMVF PMSVC PMFVC For improved system response and rigidity	100 (0~200)	RUN
F15.34 (0x0F22)	ADRC input coefficient b	V/F SVC FVC PMVF PMSVC PMFVC For improved system response and rigidity	32 (1~200)	RUN
F15.35 (0x0F23)	adrc switch	V/F SVC FVC PMVF PMSVC PMFVC adrc and pi switch	1 (0~1)	STOP
F15.36 (0x0F24)	Torque feedforward gain	V/F SVC FVC PMVF PMSVC PMFVC Torque feed-forward gain during position control	0.00 (0.00~ 100.00)	RUN

4.19 F24: Spindle control

Parameter code (address)	Name	Content	Factory default (Predetermined area)	Adjustable properties
F24.00 (0x5800)	Spindle positioning enable selection	V/F SVC FVC PMVF PMSVC PMFVC 0: Disable 1: Enable	0 (0~1)	STOP
F24.01 (0x5801)	Ready to stop positioning zero point	V/F SVC FVC PMVF PMSVC PMFVC 0: z pulse 1: proximity switch	0 (0~1)	STOP

F24.02 (0x5802)	Zero update mode	V/F SVC FVC PMVF PMSVC PMFVC 0: Only update for the first time after power-on 1: Each time the zero edge delay signal is updated	0 (0~1)	STOP
F24.03 (0x5803)	Directional mode 2 operation mode	V/F SVC FVC PMVF PMSVC PMFVC 0: Positioning mode 2 runs less than 1 revolution 1: Positioning mode 2 running Spindle running more than 1 revolution	0 (0~1)	STOP
F24.04 (0x5804)	Direction of running direction	V/F SVC FVC PMVF PMSVC PMFVC 0: shortest travel principle 1: forward 2: reverse	0 (0~2)	STOP
F24.05 (0x5805)	Directional speed	V/F SVC FVC PMVF PMSVC PMFVC Set the speed when looking for z-pulses or proximity switches	5.00 (0.01~ 100.00Hz)	STOP
F24.06 (0x5806)	Directional acceleration and deceleration time	V/F SVC FVC PMVF PMSVC PMFVC Set acceleration / deceleration time when searching for z pulse or proximity switch	3.00s (0.01~ 100.00s)	STOP
F24.07 (0x5807)	Spindle indexing offset	V/F SVC FVC PMVF PMSVC PMFVC Set the spindle index offset value	0 (0~65535)	STOP

SD500spindle servo driver

F24.08 (0x5808)	Spindle indexing position 1	V/F SVC FVC PMVF PMSVC PMFVC Set the spindle indexing position 1	0 (0~65535)	STOP
F24.09 (0x5809)	Spindle indexing position 2	V/F SVC FVC PMVF PMSVC PMFVC Set the spindle indexing position 2	0 (0~65535)	STOP
F24.10 (0x580A)	Spindle indexing position 3	V/F SVC FVC PMVF PMSVC PMFVC Set the spindle indexing position 3	0 (0~65535)	STOP
F24.11 (0x580B)	Spindle indexing position 4	V/F SVC FVC PMVF PMSVC PMFVC Set the spindle indexing position 4	0 (0~65535)	STOP
F24.12 (0x580C)	Spindle indexing position 5	V/F SVC FVC PMVF PMSVC PMFVC Set the spindle indexing position 5	0 (0~65535)	STOP
F24.13 (0x580D)	Spindle indexing position 6	V/F SVC FVC PMVF PMSVC PMFVC Set the spindle indexing position 6	0 (0~65535)	STOP
F24.14 (0x580E)	Spindle indexing position 7	V/F SVC FVC PMVF PMSVC PMFVC Setting the spindle indexing position 7	0 (0~65535)	STOP
F24.15 (0x580F)	Spindle indexing position 8	V/F SVC FVC PMVF PMSVC PMFVC Set the spindle indexing position 8	0 (0~65535)	STOP
F24.16 (0x5810)	Indexing selection terminal change to determine the delay	V/F SVC FVC PMVF PMSVC PMFVC Set the index selection terminal to determine the effective delay	0.010S (0.000~ 1.000S)	STOP
F24.20 (0x5814)	Proportional stop position loop proportional gain	V/F SVC FVC PMVF PMSVC PMFVC Set the proportional stop loop proportional gain	60.0Hz (0.1~ 600.0Hz)	RUN

SD500spindle servo driver

F24.21 (0x5815)	Proportional stop speed loop proportional gain	V/F SVC FVC PMVF PMSVC PMFVC Set the proportional stop loop proportional gain	20.00 (0.01~ 100.00)	RUN
F24.22 (0x5816)	Accurate stop speed loop integration time	V/F SVC FVC PMVF PMSVC PMFVC Set the ready to stop speed loop integration time	0.050s (0.000~ 6.000s)	RUN
F24.23 (0x5817)	Zero speed ready to stop position loop proportional gain	V/F SVC FVC PMVF PMSVC PMFVC Set proportional gain of zero speed ready to stop position loop	40.0Hz (0.1~ 600.0Hz)	RUN
F24.24 (0x5818)	Zero speed position loop output limit	V/F SVC FVC PMVF PMSVC PMFVC Limit the position loop output amplitude at zero speed	2.5% (0.0~ 100.0%)	RUN
F024.25 (0x5819)	Proximity switch equivalent number of pulses	V/F SVC FVC PMVF PMSVC PMFVC The number of pulses per turn during the ready to stop of the proximity switch is automatically set during self-learning.	0 (0~65535)	STOP
F24.30 (0x581E)	Rigid tapping input selection	V/F SVC FVC PMVF PMSVC PMFVC 0: ai1 analog tapping 1: pulse rigid tapping	1 (0~1)	STOP
F24.31 (0x581F)	Tapping acceleration time	V/F SVC FVC PMVF PMSVC PMFVC Set rigid tapping acceleration time	1.00s (0.01~ 650.00s)	RUN
F24.32 (0x5820)	Tapping deceleration time	V/F SVC FVC PMVF PMSVC PMFVC Set rigid tapping deceleration time	1.00s (0.01~ 650.00s)	RUN



F24.33 (0x5821)	Tapping (position) speed	V/F SVC FVC PMVF PMSVC PMFVC Set the maximum rigid tapping speed	5.00Hz (0.01 ~ max frequency)	RUN
F24.40 (0x5828)	Swing angle	V/F SVC FVC PMVF PMSVC PMFVC Set position swing angle	45.0 (0.0~359.9)	RUN
F24.41 (0x5829)	Swing speed	V/F SVC FVC PMVF PMSVC PMFVC Set position swing speed	2.00Hz (0.00~ 100.00Hz)	RUN
F24.42 (0x582A)	Swing acceleration and deceleration time	V/F SVC FVC PMVF PMSVC PMFVC Set position swing deceleration time	5.00s (0.01~ 100.00s)	RUN

4.20 C0x Group: Monitoring parameters

Group c00: Basic monitoring

Parameter code	Name	Parameter code	Name
C00.00 (0x2100)	Given frequency	C00.20 (0x2114)	Analog output ao
C00.01 (0x2101)	Output frequency	C00.21 (0x2115)	Keep
C00.02(0x2102)	Output current	C00.22 (0x2116)	Counter count value
C00.03 (0x2103)	Input voltage	C00.23 (0x2117)	Running time of this
C00.04 (0x2104)	The output voltage	C00.24 (0x2118)	Cumulative running time
C00.05 (0x2105)	Mechanical speed	C00.25 (0x2119)	Spindle driver power
C00.06 (0x2106)	Given torque	C00.26 (0x211A)	Spindle driver rated
C00.07 (0x2107)	Output torque	C00.27 (0x211B)	Spindle driver rated
C00.08 (0x2108)	pid given amount	C00.28 (0x211C)	Software version
C00.09 (0x2109)	pid feedback	C00.29 (0x211D)	pg feedback frequency
C00.10 (0x210A)	Output Power	C00.30 (0x211E)	Timer time

C00.11 (0x210B)	bus voltage	C00.31 (0x211F)	pid output value
C00.12 (0x210C)	Module temperature 1	C00.32 (0x2120)	Spindle drive software
C00.13 (0x210D)	Module temperature 2	C00.33(0x2121)	Encoder feedback angle
C00.14 (0x210E)	Input terminal x is on	C00.34 (0x2122)	Cumulative z-pulse error
C00.15 (0x210F)	Output terminal y is on	C00.35 (0x2123)	z pulse count
C00.16(0x2110)	Ai1 input value	C00.36 (0x2124)	Failure warning code
C00.17 (0x2111)	Analog ai2 input value	C00.37 (0x2125)	Cumulative power
C00.18 (0x2112)	Keyboard potentiometer	C00.38 (0x2126)	Cumulative power
C00.19 (0x2113)	Pulse signal pul input	C00.39 (0x2127)	Power factor angle

Note: For example, when terminals x1 and x2 are on, c00.14 is displayed as  When terminal y and relay are on, c00.15 is displayed as .

Group c01: fault monitoring

Parameter code (address)	Name	Parameter code (address)	Name
C01.00 (0x2200)	Fault type diagnostic	C01.12 (0x220C)	Frequency of previous fault
C01.01 (0x2201)	Troubleshooting information	C01.13 (0x220D)	Output voltage of the previous fault
C01.02 (0x2202)	Fault operating frequency	C01.14 (0x220E)	Last fault output current
C01.03 (0x2203)	Fault output voltage	C01.15 (0x220F)	The previous fault bus voltage
C01.04 (0x2204)	Fault output current	C01.16 (0x2210)	Temperature of the previous faulty module
C01.05 (0x2205)	Fault bus voltage	C01.17 (0x2211)	State of previous spindle drive failure
C01.06 (0x2206)	Failure module temperature	C01.18 (0x2212)	State of the previous fault input terminal

C01.07 (0x2207)	Faulty spindle drive status	C01.19 (0x2213)	State of the previous fault output terminal
C01.08 (0x2208)	Fault input terminal status	C01.20 (0x2214)	First 2 failure types
C01.09 (0x2209)	Fault output terminal status	C01.21 (0x2215)	First 2 fault diagnosis messages
C01.10 (0x220A)	Previous 1 fault type	C01.22 (0x2216)	First 3 failure types
C01.11 (0x220B)	Previous fault diagnosis information	C01.23 (0x2217)	The first 3 fault diagnosis information

Group c02: Application monitoring

Parameter code (address)	Name	Parameter code (address)	Name
C02.00 (0x2300)	pid feedback	C02.06 (0x2306)	plc stage frequency
C02.01 (0x2301)	pid given	C02.07 (0x2307)	plc phase runtime
C02.02 (0x2302)	PID output	C02.08 (0x2308)	Forward and reverse command given
C02.03 (0x2303)	PID control status	C02.09 (0x2309)	Jog command given
C02.05 (0x2305)	PLC operation phase	C02.63 (0x233F)	Built-in keyboard version

C04 组 : spindle feedback monitoring

Parameter code (address)	name	Parameter code (address)	name
C04.00 (0x2500)	Spindle position (pulse)	C04.25 (0x2519)	Spindle encoder pulse
C04.01 (0x2501)	Spindle position (angle)	C04.26 (0x251A)	Spindle encoder position
C04.02 (0x2502)	Spindle zero point count	C04.27 (0x251B)	Spindle encoder Z pulse detection times
C04.03 (0x2503)	Spindle external zero point count	C04.28 (0x251C)	Accumulation of Z pulse error of spindle encoder
C04.04 (0x2504)	External zero position of spindle	C04.29 (0x251D)	Spindle encoder frequency (PU)
C04.15	Position error		

C05 组 : position control monitoring

Parameter code (address)	name	Parameter code (address) Parameter code (address)	name
C05.20 (0x2614)	Pulse instruction count	C05.25 (0x2619)	Motor encoder pulse count
C05.21 (0x2615)	Pulse count increment	C05.26 (0x261A)	Motor encoder position
C05.22 (0x2616)	Pulse counting frequency	C05.27 (0x261B)	Motor encoder Z pulse detection times
C05.23 (0x2617)	X7 pulse count	C05.28 (0x261C)	Motor encoder Z pulse error accumulation
C05.24 (0x2618)	X7 pulse counting frequency	C05.29 (0x261D)	Motor encoder frequency (PU)

4.21 terminals inputs/outputs function options

Xoptions	Functional interpretation	X option	Functional interpretation	X option	Functional interpretation
0	No function	29	PID feedback switching 3	58	Run output blocking instruction
1	Forward running	30	Program Run (PLC)	59	Keep
2	Run in reverse	31	Program run (PLC) restart	60	Speed torque control switching
3	Three-wire operation control (Xi)	32	Acceleration / deceleration time	61	Rigid tapping / pulse position control
4	Forward jog	33	Acceleration / deceleration time	62	Keep
5	Reverse jog	34	Acceleration / deceleration pause	63	Keep
6	Free parking	35	Swing frequency input	64	Zero servo command
7	emergency pull over	36	Swing frequency pause	65	Keep
8	Fault reset	37	Swing frequency reset	66	Keep
9	External fault input	38	Keyboard keys and	67	Keep
10	Frequency increase	39	X4 frequency	68	Keep
11	Decreasing frequency	40	Timer trigger terminal	69	Position gain switching

12	Frequency increasing and decreasing clear (UP / DW clear)	41	Timer clear terminal	70	X7 pulse direction switching
13	Channel A to Channel B	42	Counter clock input	71	Pulse input disabled
14	Frequency channel combination switch to A	43	Counter clear terminal	72	Clear pulse error
15	Frequency channel combination switch to B	44	DC brake command	73	Pulse forward rotation prohibited
16	Multi-speed terminal 1	45	Pre-excitation command terminal	74	Pulse Reverse Disable
17	Multi-speed terminal 2	46	Keep	75	Keep
18	Multi-speed terminal 3	47	Keep	76	Keep
19	Multi-speed terminal 4	48	Command channel switch to keyboard	77	Keep
20	PID control canceled	49	Command channel switch to terminal	78	Keep
21	PID control suspended	50	Command channel switch to communication	79	Keep
22	PID characteristic switching	51	Keep	80	Spindle ready to stop enable
23	PID parameter	52	Operation prohibited	81	Indexing selection 1
24	PID reference switch 1	53	Forward rotation	82	Indexing selection 2
25	PID reference switch 2	54	Reverse prohibition	83	Indexing selection 3
26	PID reference switch 3	55	Keep	84	Proximity switch
27	PID feedback switching	56	Keep	85	Swing enable
28	PID feedback switching	57	Keep		
Y option	Functional interpretation	Y option	Functional interpretation	Y option	Functional interpretation
0	no output	15	Program run cycle completed	30	Communication address 0x3018 control output
1	Spindle drive running	16	The program operation phase is completed.	31	Overheating warning of spindle drive

2	Spindle drive is running in reverse	17	PID feedback exceeds the upper limit	32	Motor overheating alarm output
3	Spindle drive is running forward	18	PID feedback is below the lower limit	33	Select motor 2
4	Fault trip alarm 1 (alarm during fault self-recovery)	19	PID feedback sensor disconnected	34	Running pause output (module blocked)
5	Fault trip alarm 2 (no alarm during fault self-recovery)	20	Meter length reached	35	Torque limiting
6	External fault shutdown	21	Timer timeout	36	Speed limit
7	Spindle driver undervoltage	22	Counter reaches maximum	37	Comparator 1
8	Spindle driver ready for operation	23	Counter reaches set value	38	Comparator 2
9	Output frequency level detection 1 (FDT1)	24	Energy braking	39	Zero Servo End
10	Output frequency level detection 2 (FDT2)	25	PG feedback disconnected	40	Position positioning completed
11	Arrived at a given frequency	26	Emergency stop	41	Spindle ready to stop completed
12	Zero speed operation	27	Overload pre-alarm	42	Position control
13	Upper frequency	28	Underload pre-alarm	43	Location positioning
14	Lower limit frequency reached	29	Warning for spindle drive		

4.22 fault and warning code table

note: the number in the code bar brackets is error or warning code (Dec.means decimalism)。

Keyboard display (Dec.)	Fault name	Fault type	Keyboard display (Dec.)	Fault name	Fault type
E.SC1 (1)	System failure during acceleration	fault	E.TExx (52)	Motor parameter self-learning failure	fault
E.SC2 (2)	System failure during deceleration	fault	E.IAE1 (71)	Motor angle learning failure 1	fault

SD500spindle servo driver

E.SC3 (3)	System failure at constant speed	fault	E.IAE2 (72)	Motor perspective learning failure 2	fault
E.SC4 (4)	System failure	fault	E.IAE3 (73)	Motor angle learning failure 3	fault
E.OC1 (5)	Overcurrent during acceleration	fault	E.PST1 (74)	Synchronous machine out of step failure 1	fault
E.OC2 (6)	Overcurrent during deceleration	fault	E.PST2 (75)	Synchronous machine out of step failure 2	fault
E.OC3 (7)	Overcurrent at constant speed	fault	E.PST3 (76)	Synchronous machine out of step failure 3	fault
E.OU1 (9)	Accelerated medium pressure	fault	E.DEF (77)	Excessive speed deviation	fault
E.OU2 (10)	Overvoltage during deceleration	fault	E.SPD (78)	Rapid failure	fault
E.OU3 (11)	Overvoltage at constant speed	fault	E.LD1 (79)	Load protection 1	fault
E.LU (13)	Undervoltage during operation	fault	E.LD2 (80)	Load protection 2	fault
E.OL1 (14)	Motor overload	fault	E.CPU (81)	CPU timeout failure	fault
E.OL2 (15)	Spindle drive overload 1	fault	E.LOC (85)	Chip lock	fault
E.OL3 (16)	Spindle drive overload 2	fault	E.EEP (86)	Parameter storage failure	fault
E.OL4 (17)	Spindle drive overload 3	fault	E.BUS5 (95)	CPLD communication error 1	fault
E.ILF (18)	Input phase loss	fault	E.BUS6 (96)	CPLD communication error 2	fault
E.OLF (19)	Three-phase output lack of phase	fault	E.CP1 (97)	Monitor comparison output 1 failure	fault
E.OLF1 (20)	U-phase output lack of phase	fault	E.CP2 (98)	Monitor comparison output 2 failure	fault
E.OLF2 (21)	V-phase output phase loss	fault	E.DAT (99)	Parameter setting error	fault

SD500spindle servo driver

E.OLF3 (22)	W-phase output phase loss	fault	E.POE (100)	Out of position fault	fault
E.OH1 (30)	Rectifier module over temperature	fault	Following is the warning code		
E.OH2 (31)	IGBT module over temperature	fault	A.LU1 (128)	Undervoltage at shutdown	warning
E.EF (33)	External fault	fault	A.OU (129)	Overvoltage during shutdown	warning
E.CE (34)	modbus communication failure	fault	A.ILF (130)	Input phase loss	warning
E.HAL1 (35)	U-phase zero drift	fault	A.PID (131)	PID feedback disconnected	warning
E.HAL2 (36)	V phase zero drift	fault	A.EEP (132)	Parameter storage warning	warning
E.HAL (37)	Three-phase current sum non-zero fault	fault	A.DEF (133)	Excessive speed deviation	warning
E.HAL3 (38)	W phase zero drift	fault	A.SPD (134)	Rapid warning	warning
E.SGxx (40)	Short to ground	fault	A.GPS1	GPS lock	warning
E.FSG (41)	Fan short circuit	fault	A.GPS2	GPS disconnected	warning
E.PID (42)	PID feedback disconnected	fault	A.CE (137)	External warning	warning
E.COP (43)	Parameter copy failure	fault	A.LD1 (138)	Load protection 1	warning
E.PG1 (44)	PG parameter setting	fault	A.LD2 (139)	Load protection 2	warning
E.PG2 (44)	Encoder Z pulse failure	fault	A.OH1 (141)	Module over-temperature warning	warning
E.PG5 (44)	ABZ encoder disconnected	fault	A.OH3 (142)	Motor over-temperature warning	warning
E.PG6 (44)	Broken spindle encoder	fault	A.RUN1 (143)	Run command conflict	warning

E.PG7 (44)	Spindle encoder Z pulse error failure	fault	A.POE (156)	Out of position warning	warning
E.PG8 (44)	Encoder Z pulse logic failure	fault	A.RUN2 (158)	Jog terminal start protection	warning
E.PG9 (44)	Spindle encoder Z pulse logic failure	fault	A.RUN3 (159)	Terminal start protection	warning
E.PG10 (44)	Encoder Z pulse disconnection	fault	A.CP1 (146)	Monitor comparison output 1	warning
E.BRU (50)	Brake unit failure	fault	A.CP2 (147)	Monitor comparison output 2 warning	warning

Chapter5 the application guidance of spindle functions

5.1 motor self-learning

The motor need self-learning before debugging, wiring please refer to the wiring diagram of control circuit, related parameters as follows:

Parameter code(address)	name	contents	Factory default (predetermined area)	Adjustable properties
F02.00 (0x0200)	Motor type	V/F SVC FVC PMVF PMSVC PMFVC Set Motor type 0: AM 1: PM	0 (0~1)	READ
F02.01 (0x0201)	Number of motor poles	V/F SVC FVC PMVF PMSVC PMFVC Set the number of motor poles.	4 (2~98)	STOP
F02.02 (0x0202)	Motor rated power	V/F SVC FVC PMVF PMSVC PMFVC	Model selection (0.1~1000.0kW)	STOP

SD500spindle servo driver

		Set motor rated power		
F02.03 (0x0203)	Motor rated frequency	V/F SVC FVC PMVF PMSVC PMFVC Set Motor rated frequency	Model selection (0.01~maximum frequency)	STOP
F02.04 (0x0204)	Motor rated speed	V/F SVC FVC PMVF PMSVC PMFVC Set Motor rated speed	Model selection (0~65000rpm)	STOP
F02.05 (0x0205)	Motor rated voltage	V/F SVC FVC PMVF PMSVC PMFVC Set Motor rated voltage	Model selection (0~1500V)	STOP
F02.06 (0x0206)	Motor rated current	V/F SVC FVC PMVF PMSVC PMFVC Set Motor rated current	Model selection (0.1~3000.0A)	STOP
F02.07 (0x0207)	Motor parameter auto-tuning selection	V/F SVC FVC PMVF PMSVC PMFVC After Motor parameter auto-tuning selection, the quantitative value of [F02.07] will be automatically set as "0" 0: no operation 1: stationary self-study+rotational self-study	0 (0~7)	STOP
F02.30 (0x021E)	Speed feedback encoder type	V/F SVC FVC PMVF PMSVC PMFVC 0: ordinary ABZ encoder 1: rotating transformer 2: sine cosine encoder	0 (0~2)	STOP
F02.31 (0x021F)	Encoder direction	V/F SVC FVC PMVF PMSVC PMFVC 0: same direction 1:opposite	0 (0~1)	STOP

		direction		
F02.32 (0x0220)	ABZ encoder Z pulse detection selection	V/F SVC FVC PMVF PMSVC PMFVC 0: turn on 1: turn off (positive pulse) 2: turn on(negative pulse)	1 (0~1)	STOP
F02.33 (0x0221)	ABZ encoder line number	V/F SVC FVC PMVF PMSVC PMFVC Set ABZ encoder lines.	2500 (1~10000)	STOP
F02.40 (0x0228)	Encoder installation position	V/F SVC FVC PMVF PMSVC PMFVC 0: single motor encoder 1: single- spindle encoder 2: dual encoder	0 (0~2)	STOP
F02.43 (0x022B)	Number of positioning encoder lines	V/F SVC FVC PMVF PMSVC PMFVC Set ABZ encoder lines.	1024 (1~10000)	STOP
F02.45 (0x022D)	Crossover output configuration	V/F SVC FVC PMVF PMSVC PMFVC Units digit: frequency division output encoder rotation 0: motor encoder 1: spindle encoder Tens digit: frequency division direction 0: forward 1: reverse	0x0010 (0x0000~0x1111)	STOP

Change F02.07 to 1 to perform rotation self-learning. Display r-00 and continue to press the SET key for 1 second until r-01 appears to start self-learning.

In the application of the spindle, there are various transmission mechanisms and connection methods, so the correct connection and application are selected correctly during self-learning. At present, the installation position of the encoder is selected by F2.40: single motor encoder, single spindle encoder, dual encoder.
one. Single motor encoder mode (F2.40 = 0)

Single motor mode only needs to set the number of motor encoder lines, and then F2.07 is set to start self-learning.

F15.28 (0x0F1C)	Gear ratio pulse number numerator	V/F SVC FVC PMVF PMSVC PMFVC Set pulse number of the numerator encoder in gear ratio	1000 (0~65535)	RUN
F15.29 (0x0F1D)	Gear ratio pulse number denominator	V/F SVC FVC PMVF PMSVC PMFVC Set pulse number of the denominator encoder in gear ratio	1000 (0~65535)	RUN
F24.01 (0x5801)	Ready to stop positioning zero point	V/F SVC FVC PMVF PMSVC PMFVC 0: Z pulse 1: proximity switch	0 (0~1)	STOP
F024.25 (0x5819)	Proximity switch equivalent number of pulses	V/F SVC FVC PMVF PMSVC PMFVC The number of pulses per turn when the proximity switch is ready to stop. automatically set when it is in self-study mode.	0 (0~65535)	STOP

After self-learning, manually modify F15.28 / F15.29 to change the speed control transmission ratio.

In addition, if you use an external proximity switch for positioning, you need to select F24.01 = 1, and then perform self-learning. The number of equivalent one-cycle pulses learned will be filled in F24.25, which can be fine-tuned.

I. Single-spindle encoder mode (F2.40 = 1)

Because the encoder is installed on the spindle and there is a certain transmission ratio with the actual operation of the motor, it is necessary to select F2.40 = 1 for self-learning.

F02.35 (0x0223)	Encoder transmission ratio numerator	V/F SVC FVC PMVF PMSVC PMFVC Set Encoder transmission ratio numerator	1 (1~ 32767)	RUN
F02.36 (0x0224)	Encoder transmission ratio denominator	V/F SVC FVC PMVF PMSVC PMFVC Set Encoder transmission ratio denominator	1 (1~ 32767)	RUN

In this mode, the gain is correspondingly weakened to prevent severe vibrations.

I. Dual encoder mode (F2.40 = 2)

The dual encoder mode has both a motor encoder and a spindle encoder, so at this time, the number of encoder lines is set, and self-learning can be performed directly.

F15.28 (0x0F1C)	transmission ratio pulse number numerator	V/F SVC FVC PMVF PMSVC PMFVC Set transmission ratio pulse number numerator	1000 (0~65535)	RUN
F15.29	transmission ratio	V/F SVC FVC PMVF PMSVC PMFVC	1000	RUN

(0x0F1D)	pulse number denominator	Set transmission ratio pulse number denominator	(0~65535)	
F02.33 (0x0221)	ABZ encoder line number	V/F SVC FVC PMVF PMSVC PMFVC Set ABZ encoder line number	2500 (1~10000)	STOP
F02.43 (0x022B)	Number of positioning encoder lines	V/F SVC FVC PMVF PMSVC PMFVC Set Number of positioning encoder lines	1024 (1~10000)	STOP
F02.45 (0x022D)	Frequency division output configuration	V/F SVC FVC PMVF PMSVC PMFVC Units digit: Frequency division output encoder rotation 0: motor encoder 1: spindle encoder Tens digit: frequency division output direction 0: forward 1: reverse	0x0010 (0x0000~ 0x1111)	STOP

In the dual-encoder mode, self-learning will automatically learn the numerator and denominator of the transmission ratio during the speed control of F15.28 / 29. If the speed still deviates in the speed mode, you can manually adjust F15.28 / F15.29 to change the transmission ratio.

5.2 forward and reverse in speed mode

Parameter code (address)	name	content	Factory default (predetermined area)	Adjustable properties
F01.02 (0x0102)	Frequency reference source channel A	V/F SVC FVC PMVF PMSVC PMFVC Set frequency source channel A of spindle driver 0: keyboard number given 1: keyboard analog potentiometer given 2: voltage analog quantity AI1 given 3: current/voltage analog quantity AI2 given 4: no-bonding 5: terminal pulse PUL given 6: RS485 communication port given 7: terminal UP/DW control 8: PID control given 9: PLC given 10: positioning pulse terminal given	10 (0~11)	RUN

		11: multi-speed given		
F01.10 (0x010A)	Maximum frequency	V/F SVC FVC PMVF PMSVC PMFVC settable maximum frequency of spindle driver.	150.00Hz (maximum frequency~ 600.00Hz)	STOP
F01.12 (0x010C)	Digital setting of upper frequency	V/F SVC FVC PMVF PMSVC PMFVC When F01.11 is set to 0, the upper limit frequency is given.	150.00Hz (0.00~ Maximum frequency)	RUN
F01.22 (0x0116)	Acceleration time 1	V/F SVC FVC PMVF PMSVC PMFVC Time needed by output frequency accelerates from 0.00Hz to time reference frequency. 1~65000s(F01.21 = 0) 0.1~6500.0s(F01.21 = 1) 0.01~650.00s(F01.21 = 2)	Model settings (0.01~ 650.00s)	RUN
F01.23 (0x0117)	Deceleration time 1	V/F SVC FVC PMVF PMSVC PMFVC Time needed by output frequency decelerates from time reference frequency to 0.00Hz.	Model settings (0.01~ 650.00s)	RUN
F03.00 (0x0300)	ASR Speed Ridity Grade	V/F SVC FVC PMVF PMSVC PMFVC Ridity level settings, the higher level, the better the speed ridity is.	0 (1~25)	RUN
F03.01 (0x0301)	ASR Speed Rigid Mode	V/F SVC FVC PMVF PMSVC PMFVC ASR speed ridity mode.	0x0000 (0x0000~0xffff)	RUN
F03.02	ASR (speed	V/F SVC FVC PMVF PMSVC PMFVC	20.00	RUN

SD500spindle servo driver

(0x0302)	loop) proportional gain 1	Set ASR(speed loop)proportional gain 1.	(0.01~100.00)	
F03.03 (0x0303)	ASR (speed loop) integration time 1	V/F SVC FVC PMVF PMSVC PMFVC Set ASR(speed loop) integration time 1.	0.100s (0.000~6.000s)	RUN
F03.04 (0x0304)	ASR filter time 1	V/F SVC FVC PMVF PMSVC PMFVC Set ASR filter time 1.	0.0ms (0.0~100.0ms)	RUN
F03.05 (0x0305)	ASR switching frequency 1	V/F SVC FVC PMVF PMSVC PMFVC Set ASR switching frequency 1.	10.00Hz (0.00~max frequency)	RUN
F03.06 (0x0306)	ASR (speed loop) proportional gain 2	V/F SVC FVC PMVF PMSVC PMFVC Set ASR(speed loop) proportional gain 2.	20.00 (0.01~100.00)	RUN
F03.07 (0x0307)	ASR (speed loop) integration time 2	V/F SVC FVC PMVF PMSVC PMFVC Set ASR(speed loop) integration time 2.	0.050s (0.000~)	RUN
F03.08 (0x0308)	ASR filter time 2	V/F SVC FVC PMVF PMSVC PMFVC Set ASR filter time 2.	0.0ms (0.0~100.0ms)	RUN
F03.09 (0x0309)	ASR switching frequency 2	V/F SVC FVC PMVF PMSVC PMFVC Set ASR switching frequency 2.	5.00Hz (0.00~max frequency)	RUN

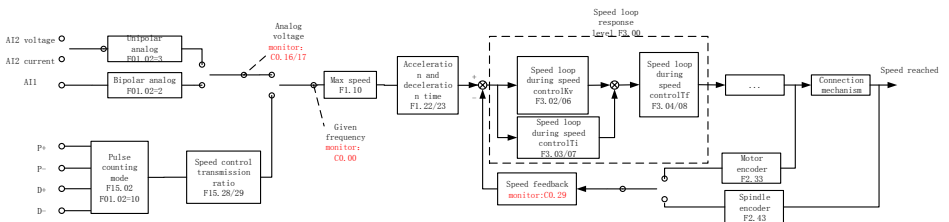

I. Analog speed control

The speed command source is given by the analog quantity, and the unipolar / bipolar operation control can be performed

according to the requirements. Unipolar does not affect the running direction and requires a running signal but bipolar influence. For example: if the analog input is +3V, the drive will rotate forward; if the analog input is -7V, the drive will reverse. The maximum value of the analog input (10V / 20mA) corresponds to the maximum frequency of the spindle servo driver. The direction can be changed by F07.05 digits.

The wiring pins and parameters involved in debugging are as follows:

Analog unipolar 0 ~ 10V / 4 ~ 20mA wiring: AI2 (16), AGND (1/3/18/32);

Analog bipolar -10V ~ +10V wiring: AI1 (17), AGND (1/3/18/32);

For analog speed control, change F01.02 (frequency given source channel A) to 3 or 2 according to unipolar or bipolar wiring, and adjust F01.10 (maximum frequency) and F01.12 (upper limit frequency) to be matched And F01.22 (acceleration time) and F01.23 (deceleration time).

Second, the pulse speed control

The speed command source is given by the pulse, and the 5V differential signals given by the CNC system are connected to PULS+ (20), PULS- (5), SIGN+ (19), SIGN- (4) respectively

The pulse type and direction are changed by F15.02 (pulse counting mode). The relevant debugging parameters are the same as the above list. F01.02 defaults to pulse reference.

Adjustment of speed control parameters

ASR is a function that adjusts the torque command by making motor speed and speed command consistent.

Before adjustment of ASR parameters

Before parameter adjustment of ASR, please be sure to implement self-learning and set all motor parameters correctly.

Please adjust the ASR parameters while the motor is connected to the load.

When adjusting ASR, you can monitor C00.01 (F11.20 bits are set to 1, select the actual output frequency) and C00.05 [motor speed], and use analog output signals.

Adjustment steps

The ASR parameter adjustment procedure is as follows.

1. Run the motor at zero or low speed, and increase F03.06 [speed loop proportional gain 2] in a range that will not cause vibration.

2. Run the motor at zero or low speed, and reduce F03.07 [speed loop integration time 2] in a range that will not cause vibration.

3. Run the motor at the set maximum speed to confirm that no vibration will occur.

4. If vibration occurs, increase the setting value of F03.07 and decrease the setting value of F03.06.

Until no more vibration occurs.

5. Set the gain in the low speed range. Run the motor at zero or low speed, and increase F03.02 [speed loop proportional gain 1] in a range that will not cause vibration.

6. The ASR proportional gain and integration time can be switched according to the output frequency. When the speed is not

stable on the low speed side, please set approximately 80% of the frequency when the actual vibration occurs; Set about 120% of the frequency when the actual vibration occurs.

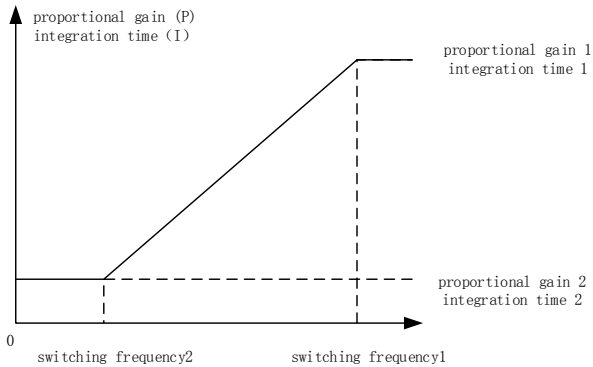

Setting diagram of speed loop proportional gain and integration time

When the setting value F03.05 is greater than F03.09, the speed loop parameters will be switched according to the output frequency.

Output frequency	Speed loop parameters		
	Proportional gain	Integration time	Filter time
Output frequency >= F03.05	F03.02	F03.03	F03.04
F03.09 < output frequency < F03.05	Linear change	Linear change	Linear change
Output frequency <= F03.09	F03.06	F03.07	F03.08

4. Self-tuning of speed control parameters

Before using the speed loop parameter auto-tuning function, you need to perform inertia identification operation (F2.07 = 7). After the self-learning is successful, set the unit of F3.01 to 4 and you will get the default response of F3.00. The level of sexuality, the rigidity level will be adjusted automatically according to the modified F3.00 level value.

5.3 Pulse position mode

In pulse position mode, it can receive high-speed pulse terminal signals, and when the X4 terminal is valid, it can perform C axis functions such as indexing and rigid tapping.

Parameter code (address)	name	content	Factory default (predetermined area)	Adjustable properties
F15.00 (0x0F00)	Position control mode selection	V/F SVC FVC PMVF PMSVC PMFVC 0: close 1: open	0 (0~1)	RUN

F15.01 (0x0F01)	Pulse position reference source	V/F SVC FVC PMVF PMSVC PMFVC 0: keyboard 1: X7 terminal 2: pulse terminal given	2 (0~2)	RUN
F15.02 (0x0F02)	Pulse counting mode	V/F SVC FVC PMVF PMSVC PMFVC 0:AB; 1:CW+CCW; 2:pulse+direction; 3:reserved; 4:AB negate; 5:CW+CCW negate; 6:pulse+direction negate; 7:reserved;	4 (0~7)	STOP
F15.03 (0x0F03)	Keyboard number given	V/F SVC FVC PMVF PMSVC PMFVC Set keyboard given pulse number.	0 (0~65535)	RUN
F15.04 (0x0F04)	Electronic gear molecule	V/F SVC FVC PMVF PMSVC PMFVC Set the numerator of electric gear ratio.	1 (1~32767)	STOP
F15.05 (0x0F05)	Electronic Gear Denominator	V/F SVC FVC PMVF PMSVC PMFVC Set the denominator of electric gear ratio.	1 (1~32767)	STOP
F15.06 (0x0F06)	Position given first order filtering time	V/F SVC FVC PMVF PMSVC PMFVC Used to filter input position signal, which makes the rotation of motor smoother.	0.0 (0.0~ 6000.0ms)	RUN
F15.07 (0x0F07)	Position given smoothing filter time	V/F SVC FVC PMVF PMSVC PMFVC Used to filter input position signal, which makes the rotation of motor smoother.	0.1 (0.0~ 512.0ms)	STOP
F15.08 (0x0F08)	Speed feedforward gain	V/F SVC FVC PMVF PMSVC PMFVC Used to improve following property of system dynamic operation.	0.0% (0.0%~ 300.0%)	RUN
F15.09 (0x0F09)	Speed feedforward filtering time	V/F SVC FVC PMVF PMSVC PMFVC Used to filter command pulse signal, to improve anti-interferenc performance.	1.0 (0.0~ 100.0ms)	RUN
F15.10	Position controller	V/F SVC FVC PMVF PMSVC PMFVC	100.0%	RUN

(0x0F0A)	output limiter	Set the limited amplitude number of position controller.	(0.0%~100.0%)	
F15.11 (0x0F0B)	Position loop proportional gain 1	V/F SVC FVC PMVF PMSVC PMFVC Used to improve system response and rigidity	50.0 (0.0~600.0Hz)	RUN
F15.12 (0x0F0C)	Position loop proportional gain 2	V/F SVC FVC PMVF PMSVC PMFVC Used to improve system response and rigidity	30.0 (0.0~600.0Hz)	RUN
F15.25 (0x0F19)	Position control ASR proportional gain	V/F SVC FVC PMVF PMSVC PMFVC Used to improve system response and rigidity	30.00 (0.01~100.00)	RUN
F15.26 (0x0F1A)	Position control ASR integration time	V/F SVC FVC PMVF PMSVC PMFVC Used to improve system response and rigidity	0.050s (0.000~6.000s)	RUN

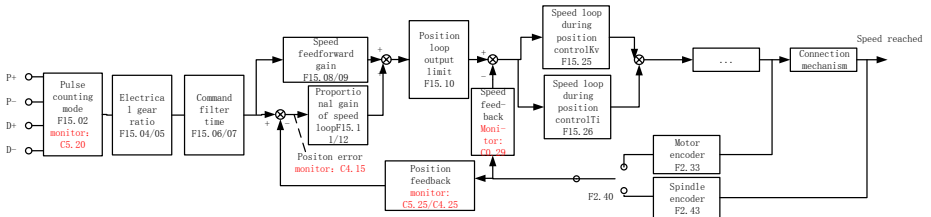

When increasing rigidity, F15.11, F15.25 should be increased, and F15.26 value should be decreased, but the jitter and sound issues need to be weighed. If jitter occurs when reaching the position, please reduce the above gain appropriately. To further improve the fast response, F15.08 speed feedforward gain can be added.

Common problems in pulse position control

Problem 1: The system is enabled but the motor is not running

Monitoring: C5.20 pulse instruction count

Judgment: If there is no change in C5.20, there may be no wiring error or wrong pulse type;

Problem 2: Position control does not reach the ready to stop position

Monitoring: C5.20 pulse instruction count, C5.25 motor encoder pulse count (spindle encoder C4.25), C4.15 position error

Judgment: If the C5.20 and C5.25 increments are the same, and C4.15 = 0, then it is judged whether the system transmission ratio and the command are set correctly; otherwise, the gain can be increased by a small amount.

5.4 Spindle ready to stop

You can use Z pulse or proximity switch for ready to stop positioning. If X3 terminal is valid, perform ready to stop.

Set the ready to stop point: Enter C04.00 to view the current value and keep pressing for 3 seconds. Exiting the current value

indicates that the setting is successful.

Parameter code (address)	name	content	Factory default(Predetermined area)	Adjustable properties
F24.00 (0x5800)	Spindle positioning enable selection	V/F SVC FVC PMVF PMSVC PMFVC 0: forbid 1: enable	0 (0~1)	STOP
F24.01 (0x5801)	Ready to stop positioning zero point	V/F SVC FVC PMVF PMSVC PMFVC 0: Z pulse 1: proximity switch	0 (0~1)	STOP
F24.02 (0x5802)	Zero update mode	V/F SVC FVC PMVF PMSVC PMFVC 0: only update when first power is on 1: every edge signal,it updates	0 (0~1)	STOP
F24.03 (0x5803)	Directional mode 2 operation mode	V/F SVC FVC PMVF PMSVC PMFVC 0: Directional mode 2: run less then 1 lap 1: Directional mode 2:spindle runs more then 1 lap	0 (0~1)	STOP
F24.04 (0x5804)	Direction of running direction	V/F SVC FVC PMVF PMSVC PMFVC 0: shortest travel principal 1: forward 2: reverse	0 (0~2)	STOP
F24.05 (0x5805)	Directional speed	V/F SVC FVC PMVF PMSVC PMFVC Set to search Z pulse or the speed of proximity switch	5.00 (0.01~100.00Hz)	STOP

F24.06 (0x5806)	Directional acceleration and deceleration time	V/F SVC FVC PMVF PMSVC PMFVC Set to search Z pulse or the acceleration/deceleration of proximity switch.	3.00s (0.01~100.00s)	STOP
F24.07 (0x5807)	Spindle indexing offset	V/F SVC FVC PMVF PMSVC PMFVC Set spindle indexing offset value.	0 (0~65535)	STOP
F24.16 (0x5810)	Indexing selection terminal change to determine the delay	V/F SVC FVC PMVF PMSVC PMFVC Set the index selection terminal to determine the effective delay	0.010S (0.000~1.000S)	STOP
F24.20 (0x5814)	allowed stop position loop proportional gain	V/F SVC FVC PMVF PMSVC PMFVC Set the allowed stop position loop proportional gain	60.0Hz (0.1~600.0Hz)	RUN
F24.21 (0x5815)	allowed stop position loop proportional gain	V/F SVC FVC PMVF PMSVC PMFVC Set the allowed stop position loop proportional gain	20.00 (0.01~100.00)	RUN
F24.22 (0x5816)	allowed stop speed loop integration time	V/F SVC FVC PMVF PMSVC PMFVC Set the allowed stop speed loop integration time	0.050s (0.000~6.000s)	RUN
F24.23 (0x5817)	Zero speed ready to stop position loop proportional gain	V/F SVC FVC PMVF PMSVC PMFVC Set the proportional gain of zero speed ready to stop position loop	40.0Hz (0.1~600.0Hz)	RUN
F24.24	Zero speed position	V/F SVC FVC PMVF PMSVC	2.5%	RUN

(0x5818)	loop output limit	PMFVC Limit the position loop output amplitude at zero speed	(0.0~100.0%)	
F024.25 (0x5819)	Proximity switch equivalent number of pulses	V/F SVC FVC PMVF PMSVC PMFVC The number of pulses in one turn when the proximity switch is ready to stop, which is automatically set when self-learning	0 (0~65535)	STOP

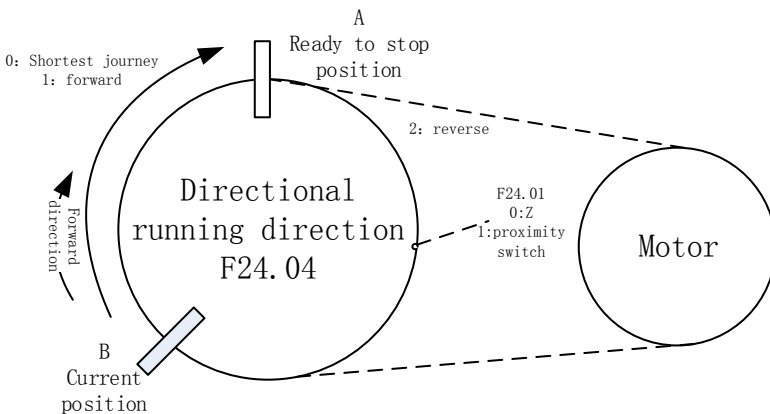

Ready to stop modes include: single encoder mode, dual encoder mode, single encoder + proximity switch mode. After determining the mode, you must set the correct parameters and perform self-learning. See the self-learning instructions for details.

Ready to stop faq

Problem 1: When the motor is stationary, the ready to stop is enabled, and the moving speed is too slow.

Treatment: Decrease the acceleration / deceleration time of F24.06 and increase the value of F24.23 / 24.

Question 2: Ready to stop is not stopped

Monitoring: C4.15 position error

Judgment: C4.15 = 0, judge whether the system mode is set correctly; rotate the axis and observe C4.00 to determine whether the ready to stop point is the desired point.

5.5 Explanation of common faults and matching problems

I. Self-learning faults related to encoder faults E. PGxx detailed fault diagnosis information is shown in the following table, where "xx" is the self-learning fault subcode, or observe C01.01 = 44xx.

Fault subcode	Troubleshooting information	Solution
1	Encoder parameter error	If motor rotation frequency is inconsistent with encoder feedback frequency, transmission ratio setting is wrong,you need to reset the numerator/denominator of transmission ratio F2.35/36.
2	Motor encoder Z pulse failure	1.encoder lines setting is wrong 2.encoder lose pulses
5	Motor encoder disconnection fault	Hardware did not detect obvious level signal. 1.encoder malfunction 2.cable is not plugged (use F2.38=0 to shield, generally not suggest to shield)
6	Broken spindle encoder failure	Hardware did not detect obvious level signal. 1.encoder malfunction 2.cable is not plugged(use F2.38=0 to shield, generally not suggest to shield)
7	Spindle encoder Z pulse failure	1.encoder lines setting is wrong 2.encoder lose pulses
8	Motor encoder Z logic failure	1.after encoder Z signal reconnected,the michine did not process self-study. (F2.07=6) 2.severe strong electric interference: ungrounded and not install shielded wire. 3.magnetic ring encoder sensor installed too far,
9	Spindle encoder Z logic failure	1.after encoder Z signal reconnected,the michine did not process self-study. (F2.07=6) 2.severe strong electric interference: ungrounded and not install shielded wire. 3.magnetic ring encoder sensor installed too far,
10	Motor encoder Z pulse missing fault	The width of Z pulse is too narrow and rotation speed is extremely fast,set F2.46 as "0"to shield
11	Spindle encoder Z pulse loss failure	The width of Z pulse is too narrow and rotation speed is extremely fast,set F2.46 as "0"to shield

注: 1.the above encoders are all incremental encoders; 2.at present,most of the faults are magnetic encoders,which associated with installation and thickness;

二、malfunction related to self-study

Self-study malfunction E. Texx detailed troubleshooting information as shown in the table below. among them “xx” is self-study malfunction subcode, or observe C01.01=52xx.

Fault subcode	troubleshooting information	solution
1	Current saturation, hall detection problem or over output current.	<ol style="list-style-type: none"> 1 Check the motor wiring for phase-to-phase short circuit. if it is wrong ,please reconnect motor wire correctly. 2.it might occur over-current when motor rotate certain angle during Synchronous motor self-study,try to study a few more times . 3.frequency inverter internal wiring is abnormal or damaged, please contact the manufacturer.
2	Excessive current bias	<ol style="list-style-type: none"> 1.check whether hall sensor has problem. 2.after several times'self-study, the fault has not been eliminated, please contact the manufacturer.
3	Current imbalance	<ol style="list-style-type: none"> 1.check whether there is interphase short circuit in motor wiring, if it is wrong ,please reconnect motor wire correctly. 2. Measure the resistance between the motor wires. If there is a deviation, replace the cable
4	Current oscillation	<ol style="list-style-type: none"> 1. Check the motor wiring for phase-to-phase short circuit. if it is wrong ,please reconnect motor wire correctly. 2. Check whether the input motor nameplate parameters are correct. If there are errors, please correct them. 3.If the set acceleration / deceleration time is too large, the current will oscillate. Reduce F01.22 [Acceleration time 1] and F01.23 [Deceleration time 1] appropriately. 4.Adjust F04.06 according to the parameter description [Oscillation suppression gain]
5	Static learning current amplitude exceeded	<ol style="list-style-type: none"> 1. Check the motor wiring for phase-to-phase short circuit. if it is wrong ,please reconnect motor wire correctly 2. Check whether the input motor nameplate parameters are correct. If there are errors, please correct them. 3. Ensure that the rated motor current is less than the inverter output current limit amplitude point.

6	Static learning U-phase current exceeded	Check the U-phase motor connection, if there is a phase-to-phase short circuit or short circuit to ground, please connect it correctly
7	Static learning V-phase current exceeded	Check the V-phase motor connection, if there is a phase-to-phase short circuit or short circuit to the ground, please connect it correctly
8	Static learning W-phase current exceeded	Check the W-phase motor connection, if there is a phase-to-phase short circuit or short circuit to the ground, please connect it correctly
9	Current continues to exceed limit during dynamic learning	<ol style="list-style-type: none"> 1. Check the motor wiring for phase-to-phase short circuit. If it is wrong, please reconnect motor wire correctly. 2. Check whether the input motor nameplate parameters are correct. If there are errors, please correct them. 3. Ensure that the load carried by the motor does not exceed 50% of the rated load. 4. Increase F01.22 [Acceleration time 1] and F01.23 [Deceleration time 1] appropriately
10	Voltage saturation	<ol style="list-style-type: none"> 1. Check the motor wiring for open circuit, If wrong, please connect the motor wire correctly. 2. Check whether the input motor nameplate parameters are correct. If there are errors, please correct them. 3. Shorten the length of the motor power line (<1000m) or increase the diameter of the motor power line.
15	Rotor resistance is too large	<ol style="list-style-type: none"> 1. Check whether the input motor nameplate parameters are correct. If there are errors, please correct them. 2. Shorten the length of the motor power line (<1000m) or increase the diameter of the motor power line.
16	Too much inductance	<ol style="list-style-type: none"> 1. Check whether the input motor nameplate parameters are correct. If there are errors, please correct them. 2. after several times' self-study, the fault has not been eliminated, please contact the manufacturer.
40	Self-study timeout	<ol style="list-style-type: none"> 1. Check whether the input motor nameplate parameters are correct. If there are errors, please correct them. 2. Check whether the inverter power level is too different from the motor power level (> 3 levels). 3. after several times' self-study, the fault has not been eliminated,

		please contact the manufacturer.
41	Parameter error	Re-enter the motor nameplate parameters correctly to ensure that the rated frequency of the motor is in the range of 10 ~ 500Hz
44	Rotor resistance is negative	1. Check whether the input motor nameplate parameters are correct. If there are errors, please correct them. 2. after several times self-study, the fault has not been eliminated, please contact the manufacturer.
45	Synchronous motor output voltage exceeded	Check whether the input motor nameplate parameters are correct. (Especially if the keyboard input rated frequency is greater than the motor nameplate ratd value), if wrong, please correct them.
46	Learning back-EMF voltage is too high	Check whether the input motor nameplate parameters are correct. (Especially if the keyboard input rated frequency is greater than the motor nameplate ratd value), if wrong, please correct them.
47	Learning back-EMF voltage is too low	1. Check whether the input motor nameplate parameters are correct. (Especially if the keyboard input rated frequency is much smaller than the motor nameplate ratd value), if wrong, please correct them. 2. Check if the motor is demagnetized
50	Motor rotation direction is wrong	1. Check if the number of encoder lines is set correctly, please correct if there are errors. 2. Check if the motor load is too heavy (> 30%) 3. Separate the motor from the machine and learn again
52	Z pulse is not detected by the synchronous machine	1. Check if the encoder Z pulse wiring is normal. 2. Check if the encoder connection cable is badly wired and causing excessive interference. 3. Make sure the encoder outputs Z pulses normally,
53	Synchronous machine Z pulse deviation is too large	1. Check if the number of encoder lines is set correctly. 2. Check if the encoder connection cable is badly wired and causing excessive interference.
61	Maximum frequency restricted	The set maximum frequency of the inverter is less than the rated frequency of the motor. Reset the maximum frequency of the inverter and the upper limit frequency to learn again.
62	Excessive deviation between	Check whether the inverter power level and the motor power level

	inverter and motor current	are too different. Please ensure that the inverter and the motor do not differ by more than 2 power levels.
90	Give stop orders while learning	Failed to complete parameter learning, need to learn again.
Other subcodes	Multiple failures while studying	1. Check if the motor wiring is correct. 2. After re-wiring, the subcode failure is still reported after learning. Seek technical support from the manufacturer.

三、System matching related issues

Definition of different CNC systems differs. If there is inconsistency with the driver when defining the positive direction, it can be matched correctly by modifying related parameters.

Problems	analyzation	solutions
CNC command direction does not match drive direction	Setting direction and pulse direction are not consistent	1. If it is analog type, modify F7.05 unit digit to change the direction of rotation. 2. For full pulse type, modify F15.02 pulse type and direction.
The drive runs in the same direction but the encoder feedback direction is inconsistent	The direction of encoder frequency division output is not consistent	Modify F2.45 tens digit direction (0 or 1).
The signal is enabled but the motor does not work	Pulse type error, no analog voltage	Check the pulse cable and pulse type, and observe the pulse command count (C5.20) or (C0.16).
Spindle running speed error	transmission ratio error	Please confirm the transmission ratio parameters on the CNC and the actual transmission ratio, and then adjust the transmission ratio of the driver.

Chapter 6 Inspection, Maintenance and warranty

6.1 inspection

The spindle drive consists of semiconductor devices, passive electronic devices, and motion devices, and these devices have a service life. Even under normal working conditions, if the service life is exceeded, some devices may have characteristics changes or failure. In order to prevent this phenomenon from causing failures, preventive inspection and maintenance such as daily inspection, periodic inspection, and device replacement must be performed. It is recommended to check every 3 to 4 months after the machine is installed.

- Daily inspection: To avoid damage to the spindle drive and shorten the service life, please check the following items daily.

items	Checking content	Treatment Measure
Power supply	Check if power supply meets the requirement and if there is lack-	Solve according to requirements on
Surroundings	Check if it meets the requirement	Find out the problem and solve it.
Cooling system	Check if the inverter or the motor heat or change color abnormally and cooling fan working state.	Check if it overloads. Tighten screw. Check if cooling fan is dirty or stall rotate.
Motor	Check if there is abnormal vibration or noise.	Tighten machine and electric connection
Load	Check if output current is over the rated value of the motor or the inverter and has lasted for a period	Check if it overloads and if the machine model is right.

- Regular Inspection: On normal cases, do one inspection every 3 or 4 months. Please decide the actual inspection period according to the machine use condition and working circumstance when using the machine.

Items	Checking Content	Treatment Measure
overall	Check insulated resistance;	Tighten and change bad component;
Electric connection	<ul style="list-style-type: none"> •Check if the color of wire and connector changes and if there is disrepair, crack color change or aging in insulating layer •Check if the connect terminals are frayed, damaged or loose. •Earth checking. 	<ul style="list-style-type: none"> •Change bad wire. •Fasten terminals and change bad terminals. •Measure earth resistance and fasten earth terminals.
Mechanical connection	<ul style="list-style-type: none"> •Check if there is abnormal vibration or noise or anything loose. 	<ul style="list-style-type: none"> •Tighten, lubricate and change the bad components.
Semi-conductive component	<ul style="list-style-type: none"> • Check if there is dust or rubbish. • If there is obvious change of appearance? 	<ul style="list-style-type: none"> • Clean operation environment • Change damaged component
Electrolytic	<ul style="list-style-type: none"> • If there is liquid leak, color change or crack. If the safety valve 	<ul style="list-style-type: none"> • Change damaged component

capacitor	outcrop, inflation, creak or liquid leak.	
Peripheral	<ul style="list-style-type: none"> ● Peripheral equipment outlook and insulation checking. 	<ul style="list-style-type: none"> ● Clear and change damaged
PCB	<ul style="list-style-type: none"> ● check if there' re peculiar smell, color change or bad rust and check if the connection is right. 	<ul style="list-style-type: none"> ● Fasten connector ● Clear PCB ● Change damaged PCB
Cooling system	<ul style="list-style-type: none"> ● Check if the fan is damaged or blocking. ● If rubbish and dust is stick to the heat sink. ● Is air inlet/outlet blocked? Or is there something sticking to the inlet/outlet. 	<ul style="list-style-type: none"> ● Clean operation environment ● Change damaged componen
Keyboard	<ul style="list-style-type: none"> ● If it is damaged. Check if display is complete. 	<ul style="list-style-type: none"> ● Change damaged component
motor	<ul style="list-style-type: none"> ● Check if there is abnormal vibration or noise. 	<ul style="list-style-type: none"> ● Tighten machine and electric connection and lubricate the machine

warning: No operation under power connecting state. Otherwise, there is danger of electric shock even death. Before operating, please cut all related equipments power, ensure that the main circuit DC current has dropped to safe range. And please operate after 5 mins.

6.2 Maintenance

All equipments and components have useful life. Right maintenance can prolong the lifetime. But damage can't be avoided. Please change the components before their lifetime is over.

component	Useful Lifetime
Fan	2~3years
Electrolytic Capacitor	4~5years
PCB	8~10years

The replacement of other components requires very strict maintenance techniques and product familiarity, and after replacement, it must pass strict testing to adapt to use, so it is not recommended that users replace other internal components by themselves. If it really needs to be replaced, please contact the agent where you purchased the product or our sales department.

6.3 Product warranty

1. If the product fails during the warranty period, please refer to the warranty terms in the warranty card for the warranty clause.
2. Primary fault diagnosis is implemented by your company in principle, but the company or its service network can provide fee-based services according to your company's requirements. According to the result of discussions with your company, if the cause of the fault is on our side, the service is free.
3. liability exemption, The inconvenience caused to your company or your customers due to the failure of our products and the damage to non-our products are not covered by our company whether or not within the warranty period.

Appendix

Appendix1 : Modbus Protocol

The communication data format is as follows:

Composition of bytes: Including start bit, 8 data bits, check bit and stop bit.

start	Bit1	Bit2	Bit3	Bit4	Bit5	Bit6	Bit7	Bit8	check bit	stop
-------	------	------	------	------	------	------	------	------	-----------	------

A frame of information must be transmitted as a continuous data stream. If the interval time is more than 1.5 bytes before the end of the entire frame transmission. The receiving device will clear these incomplete information and mistakenly believe that the following byte is the address field part of the new frame. Similarly, if the interval between the start of a new frame and the previous frame is less than 3.5 bytes, the receiving device will consider it to be a continuation of the previous frame. Due to the frame chaos, the final CRC check value is incorrect, resulting in communication error.

• Communication control parameter group address description

Function Description	Address definition	Meaning of data		R/W property
Communication given frequency	0x3000 or 0x2000	0 ~ 32000 corresponds to 0.00Hz ~ 320.00Hz		W/R
Communication command setting	0x3001 or 0x2001	0x0000: No order 0x0001: Forward running 0x0002: reverse running	0x0005: Deceleration stop. 0x0006: Free stop 0x0007: Fault reset 0x0008: Run forbidden	W/R
Spindle driver status	0x3002 or 0x2002	Bit0	0: Down 1: operating state	R
		Bit1	0: non-accelerated 1: Accelerated state	
		Bit2	0: Non-deceleration 1: Deceleration state	
		Bit3	0: forward 1: reverse	
		Bit4	0: fault-free 1: Spindle drive failure	

SD500spindle servo driver

		Bit5	0: GPRS unlock	1: GPRS lock status	
		Bit6	0: no prewarning	1: spindle driver prewarning	
Spindle driver fault code	0x3003 or 0x2003	Spindle drive current fault code (see fault code table)			R
Communication given upper limit frequency	0x3004 or 0x2004	0~32000 corresponds to 0.00Hz~320.00Hz			W/R
Communication torque setting	0x3005 or 0x2005	0~1000 corresponds to 0.0~100.0%			W/R
Torque control forward maximum frequency limit	0x3006 or 0x2006	0~1000 corresponds to 0.0~100.0%			W/R
Torque control reverse maximum frequency limit	0x3007 or 0x2007	0~1000 corresponds to 0.0~100.0%			W/R
Communication given PID set value	0x3008 or 0x2008	0~1000 corresponds to 0.0~100.0%			W/R
Communication given PID feedback value	0x3009 or 0x2009	0~1000 corresponds to 0.0~100.0%			W/R
Failure and warning code reading	0x3010 or 0x2010	0 ~ 127 is fault code 128 and above is warning code			R
Output terminal status	0x3018 or 0x2018	Externally borrowed spindle drive output terminals, Bit0 – Y1 Bit1 –TA1-TB1-TC1; Bit2 – Y2 BIT3 – TA2-TB2-TC2			R
AO1 outputs	0x3019 or 0x2019	0-10000 corresponds to output: 0-10V, 0-20mA			R

note: For other function code addresses, see the "Communication Address" column in the function code summary table.:

When using the write command (06H) to write the parameters of the F00 ~ F15 parameter group, if the highest-order bit of the function code parameter address field is 0, it is only written into the spindle drive RAM and is not stored after power-off; if the function code parameter address field is the upper nibble for 1, write to EEPROM, that is, power-down storage. Such as F00 group: 0x00XX (write RAM) 0x10XX (stored in EEPROM).When using the write command (06H) to write the parameters of the F16 ~ F29 parameter group, if the highest-order bit of the function code parameter address field is 5, it is only written into the spindle drive RAM, and it is not stored after power-off; if the function code parameter address field is high nibble for D, write to EEPROM, that is, power-down storage. Such as F16 group: 0x50XX (write RAM) 0xD0XX (stored in EEPROM).

●The meaning of the error code of the slave responding to the exception message

error code	Description	error code	Description	error code	Description
1	Command code	3	CRC check error	4	Illegal address
5	Illegal data	6	Parameters cannot be changed during	8	Spindle driver is busy (EEPROM is storing)
9	Parameter value	10	Reserved parameters	11	Wrong number of

Appendix2 : Terminal wiring

0: Two-wire control 1

Operation and direction are consistent. This mode is the most commonly used two-wire mode. The factory default is that the forward and reverse running of the motor is determined by the X1 (forward running) and X2 (reverse running) terminal commands. As shown below:

K1	K2	running command
0	0	Stop
1	0	Forward
0	1	Reverse
1	1	Stop

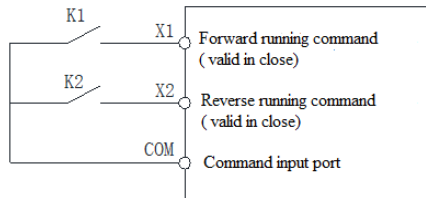

0: Two-wire control 1 schematic

1: Two-wire control 2

Separate operation from direction. The forward running terminal X1 (forward running) defined when using this mode is the running enable terminal. The definition of the direction is determined by the state of the reverse running terminal X2 (reverse running). As shown below:

K1	K2	running command
0	0	Stop
1	0	Forward
1	1	Reverse
0	1	Stop

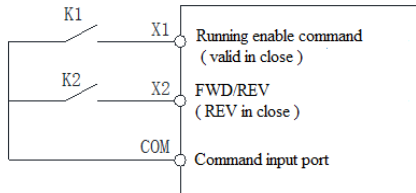

1: Two-wire control 2 schematic

2: Three-wire control 1

In this mode, the three-wire running control terminal (Xi) is a stop running terminal. The running command is generated by the forward running terminal X1 (forward running) and the direction is controlled by the reverse running terminal X2 (reverse running).

The three-wire operation control terminal (Xi) is a valid input

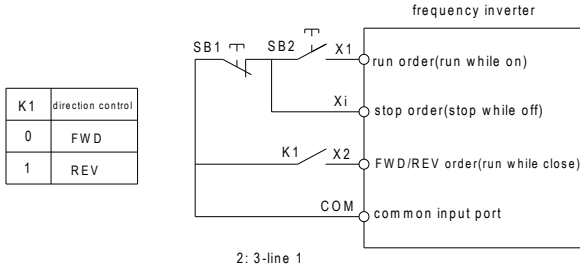

2: Three-wire control 1 schematic

3: three-wire contro 2

In this mode, the three-wire running control terminal (Xi) is a stop running terminal. The running command is generated by the forward running terminal X1 (forward running) or the reverse running terminal X2 (reverse running), and both control the running

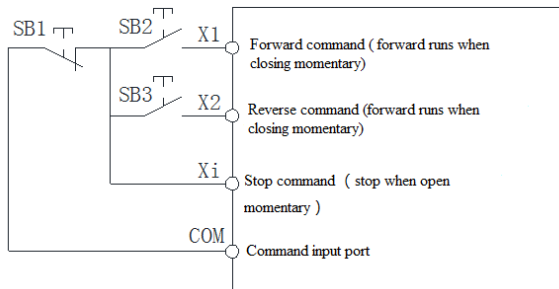

direction at the same time.

3: Three-wire control 2 schematic

Tips: SB1: Stop button; SB2: Forward run button; SB3: Reverse run button; "Xi" is a multi-function input terminal set to "3" [three-wire operation control (Xi)].

Appendix 3: Description of matching wires

1、 Multifunctional terminal wire

MUL M – L03 – SS

M:spindle servo series

MUL: CN1 multi-function terminal line

Line length
L03: 3meter
L05: 5meter
L10: 10meter

Plug type:Single-ended plug

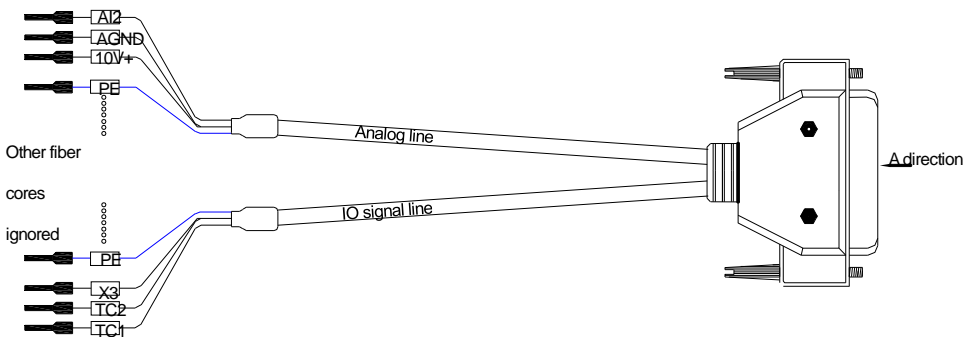

A direction

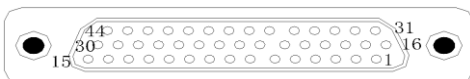

Analog line				IO signal line			
Pin number	Signal definition	Function definition	note	Pin number	Signal definition	Function definition	note
16	AI2	0~10V、 0~20mA	This 2-wire	10	X4	Multi function contact input 4	This 2-wire

SD500spindle servo driver

		Optional	twisted pair				twisted pair
18	AGND	Analog GND		25	X5	Multi function contact input 5	
4	SIGN-	Command direction-	This 2-wire	11	X1	Multi function contact input 1	This 2-wire
19	SIGN+	Command direction+	twisted pair	26	X2	Multi function contact input 2	twisted pair
5	PULS-	Pulse direction-	This 2-wire	12	24V+	inner24V,100mA	This 2-wire
20	PULS+	Pulse direction+	twisted pair	42	COM	inner+24V source	twisted pair
6	OB-	Frequency division OB-	This 2-wire	14	TA2	Relay A2	This 2-wire
21	OB+	Frequency division OB+	twisted pair	43	TC2	Relay C2	twisted pair
7	OA-	Frequency division OA-	This 2-wire	15	TA1	Relay A1	This 2-wire
22	OA+	Frequency division OA+	twisted pair	44	TC1	Relay C1	twisted pair
35	OZ-	Frequency division OZ-	This 2-wire	27	SC	I/O common end+	This 2-wire
36	OZ+	Frequency division OZ+	twisted pair	39	X7	Multi function contact input 7	twisted pair
Inner iron shell	PE	Shielding layer		28	Y2+	Open collector output 2+	This 2-wire
				13	Y1+	Open collector output 1+	twisted pair
				40	X6	Multi-function contact input 6	This 2-wire
				41	X3	Multi-function contact input 3	twisted pair
				29	TB2	Relay B2	This 2-

SD500spindle servo driver

				30	TB1	Relay B1	wire twisted pair
				Inner iron shell	PE	Shielding layer	

2. encoder lines

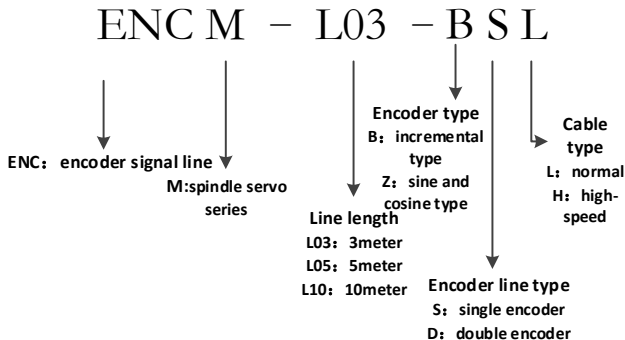

1) single encoder line

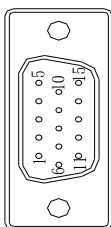
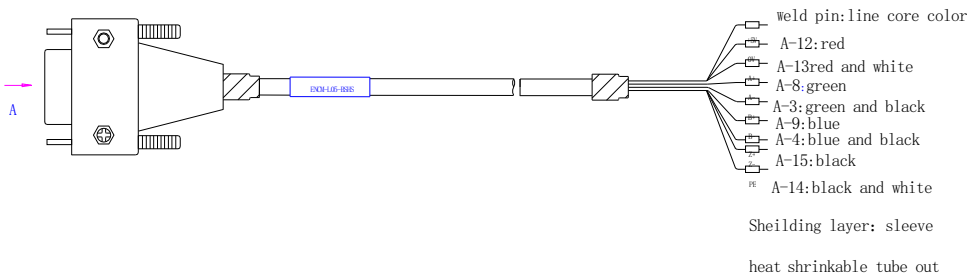
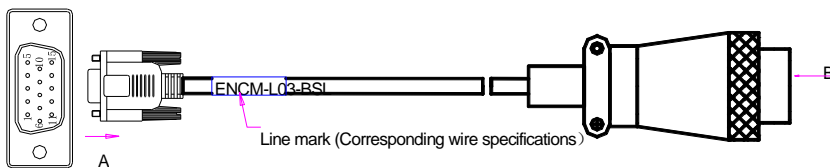

view A

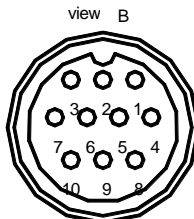

Assembled female head (jack)

signal definition	terminal A pin number (DB15)	corresponding pin position	Terminal B pin number (aviation plug)	note	
A-	3	↔	4	Twisted pair	
A+	8		3		
B-	4		6	Twisted pair	
B+	9		5		
5V	12		1	Twisted pair	
0V	13		2		
Z-	14		8	Twisted pair	
Z+	15		7		
PE	inner mental shell			10	
U-	1				Twisted pair
U+	6				
W-	2			Twisted pair	
W+	7				
V-	5			Twisted pair	
V+	10				

2) double encoder line

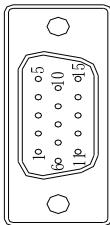
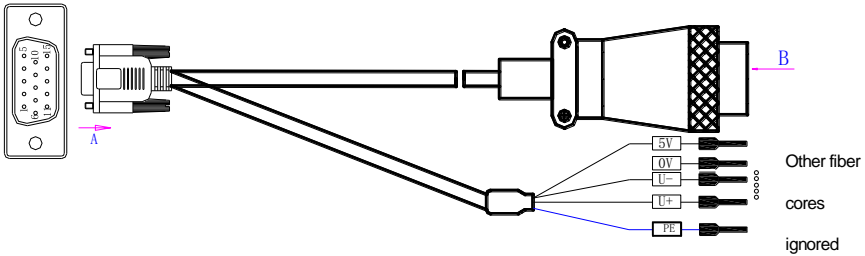

view A

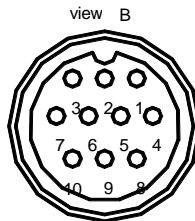

Assembled female head (jack)

signal definition	terminal A pin number(DB15)	corresponding pin position	Terminal B pin number (aviation plug)	note	
A-	3	←→	4	Twisted pair	
A+	8		3		
B-	4		6	Twisted pair	
B+	9		5		
5V	12		1	Twisted pair	
0V	13		2		
Z-	14		8	Twisted pair	
Z+	15		7		
PE (shielding layer)	inner metal shell			10	
5V	12		←→	Takeover type pre-insulated terminal	Twisted pair
0V	13	Takeover type pre-insulated terminal			
U-	1	Takeover type pre-insulated terminal		Twisted pair	
U+	6	Takeover type pre-insulated terminal			
W-	2	Takeover type pre-insulated terminal		Twisted pair	
W+	7	Takeover type pre-insulated terminal			
V-	5	Takeover type pre-insulated terminal		Twisted pair	
V+	10	Takeover type pre-insulated terminal			
T1	11	Takeover type pre-insulated terminal			